

# Dell™ PERC 6/i, PERC 6/E and CERC 6/i

## User's Guide

Model UCP-60 , UCP-61, and UCC-60

# Notes, Notices, and Cautions



**NOTE:** A NOTE indicates important information that helps you make better use of your system.



**NOTICE:** A NOTICE warns against either potential damage to hardware or of data and tells you how to avoid the problem.



**CAUTION:** A CAUTION indicates a potential for property damage, personal injury, or death.



**NOTE:** Refer to the *Product Information Guide* that came with your system for complete information about U.S. Terms and Conditions of Sale, Limited Warranties, and Returns, Export Regulations, Software License Agreement, Safety, Environmental and Ergonomic Instructions, Regulatory Notices, and Recycling Information.

---

**Information in this document is subject to change without notice.**

© 2007–2008 Dell Inc. All rights reserved.

Reproduction of these materials in any manner whatsoever without the written permission of Dell Inc. is strictly forbidden.

Trademarks used in this text: *Dell*, the *DELL* logo, *PowerEdge*, *PowerVault*, *Dell Precision*, and *OpenManage* are trademarks of Dell Inc.; *MegaRAID* is a registered trademark of LSI Corporation; *Microsoft*, *MS-DOS*, *Windows Server*, *Windows*, and *Windows Vista* are either trademarks or registered trademarks of Microsoft Corporation in the United States and/or other countries; *Citrix XenServer* is a trademark of Citrix Systems, Inc. and/or one or more of its subsidiaries, and may be registered in the U.S. Patent and Trademark Office and in other countries; *VMware* is a registered trademark of VMware, Inc. in the United States and/or other jurisdictions; *Solaris* is a trademark of Sun Microsystems, Inc.; *Intel* is a registered trademark of Intel Corporation or its subsidiaries in the United States or other countries; *Novell and NetWare* are registered trademarks, and *SUSE* is a registered trademark of Novell, Inc. in the United States and other countries; *Red Hat* and *Red Hat Enterprise Linux* are registered trademarks of Red Hat, Inc.

Other trademarks and trade names may be used in this document to refer to either the entities claiming the marks and names or their products. Dell Inc. disclaims any proprietary interest in trademarks and trade names other than its own.

**Model UCP-60, UCP-61, and UCC-60**

July 2008

P/N P412J

Rev. A00

# Contents

A	CAUTION: Safety Instructions . . . . .	11
	<b>SAFETY: General</b> . . . . .	11
	<b>SAFETY: When Working Inside Your System</b> . . . . .	12
	<b>Protecting Against Electrostatic Discharge</b> . . . . .	12
	<b>SAFETY: Battery Disposal</b> . . . . .	13
1	Overview . . . . .	15
	<b>Scope of the User's Guide</b> . . . . .	15
	<b>PERC 6 and CERC 6/i Controller Descriptions</b> . . . . .	15
	PCI Architecture . . . . .	16
	<b>Operating System Support</b> . . . . .	16
	<b>RAID Description</b> . . . . .	17
	Summary of RAID Levels . . . . .	17
	RAID Terminology . . . . .	18
2	About PERC 6 and CERC 6i Controllers . . . . .	21
	<b>PERC 6 and CERC 6i Controller Features</b> . . . . .	21
	<b>Using the SMART Feature</b> . . . . .	24

<b>Initializing Virtual Disks</b> . . . . .	<b>25</b>
Background Initialization . . . . .	25
Full Initialization of Virtual Disks. . . . .	26
Fast Initialization of Virtual Disks . . . . .	26
<b>Consistency Checks</b> . . . . .	<b>26</b>
<b>Disk Roaming</b> . . . . .	<b>27</b>
<b>Disk Migration</b> . . . . .	<b>27</b>
Compatibility With Virtual Disks Created on PERC 5 Controllers. . . . .	28
Compatibility With Virtual Disks Created on SAS 6/iR Controllers. . . . .	29
Migrating Virtual Disks from SAS 6/iR to PERC 6 and CERC 6i . . . . .	29
<b>Battery Management</b> . . . . .	<b>30</b>
Battery Warranty Information . . . . .	31
Battery Learn Cycle. . . . .	31
<b>Virtual Disk Write Cache Policies</b> . . . . .	<b>32</b>
Write-Back and Write-Through. . . . .	32
Conditions Under Which Write-Back is Employed . . . . .	33
Conditions Under Which Write-Through is Employed. . . . .	33
Conditions Under Which Forced Write-Back With No Battery is Employed . . . . .	33
<b>Virtual Disk Read Policies</b> . . . . .	<b>33</b>
<b>Reconfiguring Virtual Disks</b> . . . . .	<b>34</b>
<b>Fault Tolerance Features</b> . . . . .	<b>36</b>
Physical Disk Hot Swapping . . . . .	36
Failed Physical Disk Detection . . . . .	37

Redundant Path With Load Balancing Support . . . . .	37
Using Replace Member and Revertible Hot Spares . . . . .	37
<b>Patrol Read</b> . . . . .	<b>38</b>
Patrol Read Feature . . . . .	38
Patrol Read Modes . . . . .	39
<b>3</b> <b>Installaing and Configuring       Hardware</b> . . . . .	<b>41</b>
<b>Installing the PERC 6/E and PERC 6/i Adapters</b> . . . . .	<b>41</b>
<b>Installing the Transportable Battery     Backup Unit (TBBU) for PERC 6/E</b> . . . . .	<b>45</b>
<b>Installing the DIMM on a PERC 6/E Adapter</b> . . . . .	<b>47</b>
<b>Transferring a TBBU Between Controllers</b> . . . . .	<b>49</b>
<b>Removing the PERC 6/E and PERC 6/i Adapters</b> . . . . .	<b>50</b>
<b>Removing the DIMM and Battery from     a PERC 6/E Adapter</b> . . . . .	<b>53</b>
<b>Disconnecting the BBU from a PERC 6/i Adapter     or a PERC 6/i Integrated Controller</b> . . . . .	<b>55</b>
<b>Setting up Redundant Path Support     on the PERC 6/E Adapter</b> . . . . .	<b>56</b>
<b>Removing and Installing the CERC 6/i     Modular Storage Controller Card     (Service-Only Procedure)</b> . . . . .	<b>59</b>
Installing the Modular Storage Controller Card . . . . .	61

4	Installing the Drivers . . . . .	63
	<b>Installing Windows Driver . . . . .</b>	<b>64</b>
	Creating the Driver Media . . . . .	64
	Pre-Installation Requirements . . . . .	64
	Installing the Driver During a Windows Server 2003 or Windows XP Operating System Installation. . . . .	66
	Installing the Driver During a Windows Server 2008 or Windows Vista Installation . . . . .	66
	Installing a Windows Server 2003, Windows Server 2008, Windows Vista, or Windows XP Driver for a New RAID Controller . . . . .	67
	Updating an Existing Windows Server 2003, Windows Server 2008, Windows XP, or Windows Vista Driver . . . . .	68
	<b>Installing Linux Driver . . . . .</b>	<b>69</b>
	Installing Red Hat Enterprise Linux Operating Systems using the Driver Update Diskette . . . . .	71
	Installing SUSE Linux Enterprise Server Using the Driver Update Diskette. . . . .	71
	Installing the RPM Package With DKMS Support . . . . .	72
	<b>Installing Solaris Driver . . . . .</b>	<b>73</b>
	Installing Solaris 10 on a PowerEdge System Booting From a PERC 6 and CERC 6i Controller. . . . .	74
	Adding/Updating the Driver to an Existing System . . . . .	74

<b>Installing NetWare Driver . . . . .</b>	<b>75</b>
Installing the NetWare Driver in a New NetWare System . . . . .	75
Installing or Updating the NetWare Driver in an Existing NetWare System . . . . .	76
<b>5 Configuring and Managing RAID . . . . .</b>	<b>77</b>
<b>Dell OpenManage Storage Management . . . . .</b>	<b>77</b>
<b>Dell SAS RAID Storage Manager . . . . .</b>	<b>77</b>
<b>RAID Configuration Functions . . . . .</b>	<b>78</b>
<b>BIOS Configuration Utility . . . . .</b>	<b>79</b>
Entering the BIOS Configuration Utility. . . . .	79
Exiting the Configuration Utility. . . . .	80
Menu Navigation Controls . . . . .	80
Setting Up Virtual Disks. . . . .	83
<b>Virtual Disk Management . . . . .</b>	<b>85</b>
Creating Virtual Disks. . . . .	85
Initializing Virtual Disks. . . . .	88
Checking Data Consistency . . . . .	88
Importing or Clearing Foreign Configurations Using the VD Mgmt Menu . . . . .	89
Importing or Clearing Foreign Configurations Using the Foreign Configuration View Screen . . . . .	90
Managing Preserved Cache . . . . .	93
Managing Dedicated Hot Spares. . . . .	94
Deleting Virtual Disks. . . . .	95
Deleting Disk Groups . . . . .	95
Resetting the Configuration . . . . .	96
BIOS Configuration Utility Menu Options. . . . .	96

<b>Physical Disk Management</b> . . . . .	<b>104</b>
Setting LED Blinking . . . . .	104
Creating Global Hot Spares . . . . .	104
Removing Global or Dedicated Hot Spares . . . . .	105
Replacing an Online Physical Disk . . . . .	106
Stopping Background Initialization . . . . .	107
Performing a Manual Rebuild of an Individual Physical Disk . . . . .	107
<b>Controller Management</b> . . . . .	<b>108</b>
Enabling Boot Support . . . . .	108
Enabling BIOS Stop on Error . . . . .	109
Restoring Factory Default Settings . . . . .	110
<b>6 Troubleshooting</b> . . . . .	<b>111</b>
<b>Post Error Messages</b> . . . . .	<b>111</b>
<b>Virtual Disks Degraded</b> . . . . .	<b>117</b>
<b>Memory Errors</b> . . . . .	<b>118</b>
<b>Pinned Cache State</b> . . . . .	<b>118</b>
<b>General Problems</b> . . . . .	<b>119</b>
<b>Physical Disk Related Issues</b> . . . . .	<b>120</b>
<b>Physical Disk Failures and Rebuilds</b> . . . . .	<b>121</b>
<b>SMART Errors</b> . . . . .	<b>123</b>
<b>Replace Member Errors</b> . . . . .	<b>124</b>





<b>Linux Operating System Errors</b> . . . . .	<b>125</b>
<b>Controller LED Indicators</b> . . . . .	<b>127</b>
<b>Drive Carrier LED Indicators</b> . . . . .	<b>128</b>
<b>B Regulatory Notices</b> . . . . .	<b>131</b>
<b>C Corporate Contact Details</b> <b>(Taiwan Only)</b> . . . . .	<b>133</b>



# **CAUTION: Safety Instructions**

Use the following safety guidelines to help ensure your own personal safety and to help protect your system and working environment from potential damage.

 **CAUTION: There is a danger of a new battery exploding if it is incorrectly installed. Replace the battery only with the same or equivalent type recommended by the manufacturer. Refer to "SAFETY: Battery Disposal" on page 13.**

 **NOTE:** Refer to the safety regulations and warnings stated in the documentation that ships with your Dell™ workstation.

## **SAFETY: General**

- Observe and follow service markings. Do not service any product except as explained in your user documentation. Opening or removing covers that are marked with the triangular symbol with a lightning bolt may expose you to electrical shock. Components inside these compartments should be serviced only by a trained service technician.
- If any of the following conditions occur, unplug the product from the electrical outlet and replace the part or contact your trained service provider:
  - The power cable, extension cable, or plug is damaged.
  - An object has fallen into the product.
  - The product has been exposed to water.
  - The product has been dropped or damaged.
  - The product does not operate correctly when you follow the operating instructions.
- Use the product only with approved equipment.
- Operate the product only from the type of external power source indicated on the electrical ratings label. If you are not sure of the type of power source required, consult your service provider or local power company.
- Handle batteries carefully. Do not disassemble, crush, puncture, short external contacts, dispose of in fire or water, or expose batteries to temperatures higher than 60 degrees Celsius (140 degrees Fahrenheit). Do not attempt to open or service batteries; replace batteries only with batteries designated for the product.

# SAFETY: When Working Inside Your System

Before you remove the system covers, perform the following steps in the sequence indicated.



**CAUTION:** Except as expressly otherwise instructed in Dell documentation, only trained service technicians are authorized to remove the system cover and access any of the components inside the system.



**NOTICE:** To help avoid possible damage to the system board, wait 5 seconds after turning off the system before removing a component from the system board or disconnecting a peripheral device.

- 1 Turn off the system and any devices.
- 2 Ground yourself by touching an unpainted metal surface on the chassis before touching anything inside the system.
- 3 While you work, periodically touch an unpainted metal surface on the chassis to dissipate any static electricity that might harm internal components.
- 4 Disconnect your system and devices from their power sources. To reduce the potential of personal injury or shock, disconnect any telecommunication lines from the system.

In addition, take note of these safety guidelines when appropriate:

- When you disconnect a cable, pull on its connector or on its strain-relief loop, not on the cable itself. Some cables have a connector with locking tabs; if you are disconnecting this type of cable, press in on the locking tabs before disconnecting the cable. As you pull connectors apart, keep them evenly aligned to avoid bending any connector pins. Also, before you connect a cable, make sure that both connectors are correctly oriented and aligned.
- Handle components and cards with care. Do not touch the components or contacts on a card. Hold a card by its edges or by its metal mounting bracket. Hold a component such as a microprocessor chip by its edges, not by its pins.

## Protecting Against Electrostatic Discharge

Electrostatic discharge (ESD) events can harm electronic components inside your computer. Under certain conditions, ESD may build up on your body or an object, such as a peripheral, and then discharge into another object, such as your computer. To prevent ESD damage, you should discharge static electricity from your body before you interact with any of your computer's internal electronic components, such as a memory module. You can protect against ESD by touching a metal grounded object (such as an unpainted metal surface on your computer's I/O panel) before you interact with anything electronic. When connecting a peripheral (including handheld digital assistants) to your computer, you should always ground both yourself and the peripheral before connecting it to the computer. In addition, as you work inside the computer, periodically touch an I/O connector to remove any static charge your body may have accumulated.

You can also take the following steps to prevent damage from electrostatic discharge:

- When unpacking a static-sensitive component from its shipping carton, do not remove the component from the antistatic packing material until you are ready to install the component. Just before unwrapping the antistatic package, be sure to discharge static electricity from your body.
- When transporting a sensitive component, first place it in an antistatic container or packaging.
- Handle all electrostatic sensitive components in a static-safe area. If possible, use antistatic floor pads and work bench pads.

## SAFETY: Battery Disposal



Your system may use a nickel-metal hydride (NiMH), lithium coin-cell, and/or a lithium-ion battery. The NiMH, lithium coin-cell, and lithium-ion batteries are long-life batteries, and it is very possible that you will never need to replace them. However, should you need to replace them, refer to the instructions included in the section "Configuring and Managing RAID" on page 77.

Do not dispose of the battery along with household waste. Contact your local waste disposal agency for the address of the nearest battery deposit site.



**NOTE:** Your system may also include circuit cards or other components that contain batteries. These batteries must also be disposed of in a battery deposit site. For information about such batteries, refer to the documentation for the specific card or component.

### Taiwan Battery Recycling Mark



廢電池請回收



# Overview

The Dell™ PowerEdge™ Expandable RAID Controller (PERC) 6 family of controllers and the Dell Cost-Effective RAID Controller (CERC) 6/i offer redundant array of independent disks (RAID) control capabilities. The PERC 6 and CERC 6/i Serial Attached SCSI (SAS) RAID controllers support Dell-qualified SAS and SATA devices. The controllers are designed to provide reliability, high performance, and fault-tolerant disk subsystem management.

## Scope of the User's Guide

This user's guide for the PERC 6 and CERC 6/i controllers documents the following topics:

- Overview
- About PERC 6 and CERC 6/i controllers
- Hardware installation and configuration
- Driver installation
- RAID configuration and management
- Troubleshooting

## PERC 6 and CERC 6/i Controller Descriptions

The following list describes each type of controller:

- The PERC 6/E adapter with two external x4 SAS ports and a transportable battery backup unit (TBBU)
- The PERC 6/i adapter with two internal x4 SAS ports with or without a battery backup unit, depending on the system
- The PERC 6/i Integrated controller with two internal x4 SAS ports and a battery backup unit
- The CERC 6/i modular storage controller with one internal x4 SAS port and no battery backup unit



**NOTE:** The CERC 6/i modular storage controller is a custom form-factor card for PowerEdge M-Series Modular systems.

Each controller supports up to 64 virtual disks.

 **NOTE:** The number of virtual disks supported by the PERC 6/i and the CERC 6/i cards is limited by the configuration supported by the system.

## PCI Architecture

PERC 6 controllers support a Peripheral Component Interconnect Express (PCI-E) x8 host interface. CERC 6/i Modular controller supports a PCI-E x4 host. PCI-E is a high-performance input/output (I/O) bus architecture designed to increase data transfers without slowing down the Central Processing Unit (CPU).

## Operating System Support

The PERC 6 and CERC 6/i controllers support the following operating systems:

- Citrix® XenServer Dell Edition
- Microsoft® Windows Server® 2003
- Microsoft Windows XP
- Microsoft Windows Vista™
- Microsoft Windows Server 2008 (including Hyper-V virtualization)
- Novell® NetWare® 6.5
- Red Hat® Enterprise Linux® Version 4 Update 5 and Red Hat Enterprise Linux Version 5
- Solaris™ 10 (64-bit)
- SUSE® Linux Enterprise Server Version 9 (64-bit) and SUSE Linux Enterprise Server Version 10 (64-bit)
- VMWare® ESX 3.5 and 3.5i

 **NOTE:** Windows XP and Windows Vista are supported with a PERC 6 controller only when the controller is installed in a Dell Precision™ workstation.

 **NOTE:** For the latest list of supported operating systems and driver installation instructions, see the system documentation located at the Dell Support website at [support.dell.com](http://support.dell.com). For specific operating system service pack requirements, see the **Drivers and Downloads** section on the Dell Support site at [support.dell.com](http://support.dell.com).



# RAID Description

RAID is a group of independent physical disks that provides high performance by increasing the number of drives used for saving and accessing data. A RAID disk subsystem improves I/O performance and data availability. The physical disk group appears to the host system either as a single storage unit or multiple logical units. Data throughput improves because several disks are accessed simultaneously. RAID systems also improve data storage availability and fault tolerance. Data loss caused by a physical disk failure can be recovered by rebuilding missing data from the remaining physical disks containing data or parity.



**NOTICE:** In the event of a physical disk failure, a RAID 0 virtual disk fails, resulting in data loss.

## Summary of RAID Levels

RAID 0 uses disk striping to provide high data throughput, especially for large files in an environment that requires no data redundancy.

RAID 1 uses disk mirroring so that data written to one physical disk is simultaneously written to another physical disk. RAID 1 is good for small databases or other applications that require small capacity, but also require complete data redundancy.

RAID 5 uses disk striping and parity data across all physical disks (distributed parity) to provide high data throughput and data redundancy, especially for small random access.

RAID 6 is an extension of RAID 5 and uses an additional parity block. RAID 6 uses block-level striping with two parity blocks distributed across all member disks. RAID 6 provides protection against double disk failures and failures while a single disk is rebuilding. If you are using only one array, deploying RAID 6 is more effective than deploying a hot spare disk.

RAID 10, a combination of RAID 0 and RAID 1, uses disk striping across mirrored disks. It provides high data throughput and complete data redundancy. RAID 10 can support up to eight spans, and up to 32 physical disks per span.

RAID 50, a combination of RAID 0 and RAID 5, uses distributed data parity and disk striping and works best with data that requires high system availability, high request rates, high data transfers, and medium-to-large capacity.

RAID 60 is a combination of RAID 6 and RAID 0, a RAID 0 array is striped across RAID 6 elements. RAID 60 requires at least 8 disks.

## RAID Terminology

### Disk Striping

Disk striping allows you to write data across multiple physical disks instead of just one physical disk. Disk striping involves partitioning each physical disk storage space into stripes of the following sizes: 8 KB, 16 KB, 32 KB, 64 KB, 128 KB, 256KB, 512KB, and 1024KB. These stripes are interleaved in a repeated sequential manner. The part of the stripe on a single physical disk is called a stripe element.

For example, in a four-disk system using only disk striping (used in RAID level 0), segment 1 is written to disk 1, segment 2 is written to disk 2, and so on. Disk striping enhances performance because multiple physical disks are accessed simultaneously, but disk striping does not provide data redundancy.

Figure 2-1 shows an example of disk striping.

**Figure 2-1. Example of Disk Striping (RAID 0)**

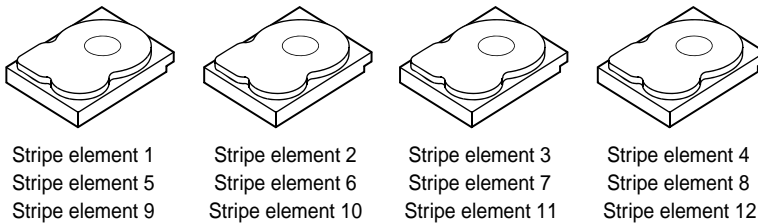

### Disk Mirroring

With mirroring (used in RAID 1), data written to one disk is simultaneously written to another disk. If one disk fails, the contents of the other disk can be used to run the system and rebuild the failed physical disk. The primary advantage of disk mirroring is that it provides 100 percent data redundancy. Because the contents of the disk are completely written to a second disk, it does not matter if one of the disks fails. Both disks contain the same data at all times. Either of the physical disks can act as the operational physical disk.

Disk mirroring provides 100 percent redundancy, but is expensive because each physical disk in the system must be duplicated. Figure 2-2 shows an example of disk mirroring.

 **NOTE:** Mirrored physical disks improve read performance by read load balance.

**Figure 2-2. Example of Disk Mirroring (RAID 1)**

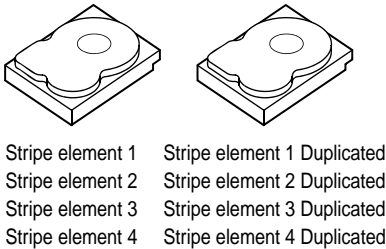

### Spanned RAID Levels

Spanning is a term used to describe the way in which RAID levels 10, 50, and 60 are constructed from multiple sets of basic, or simple RAID levels. For example, a RAID 10 has multiple sets of RAID 1 arrays where each RAID 1 set is considered a span. Data is then striped (RAID 0) across the RAID 1 spans to create a RAID 10 virtual disk. If you are using RAID 50 or RAID 60, you can combine multiple sets of RAID 5 and RAID 6 together with striping.

### Parity Data

Parity data is redundant data that has been generated to provide fault tolerance within certain RAID levels. In the event of a drive failure the parity data can be used by the controller to regenerate user data. Parity data is present for RAID 5, 6, 50, and 60.

The parity data is distributed across all the physical disks in the system. If a single physical disk fails, it can be rebuilt from the parity and the data on the remaining physical disks. RAID level 5 combines distributed parity with disk striping, as shown in Figure 2-3. Parity provides redundancy for one physical disk failure without duplicating the contents of entire physical disks.

RAID level 6 combines dual distributed parity with disk striping. This level of parity allows for two disk failures without duplicating the contents of entire physical disks.

**Figure 2-3. Example of Distributed Parity (RAID 5)**

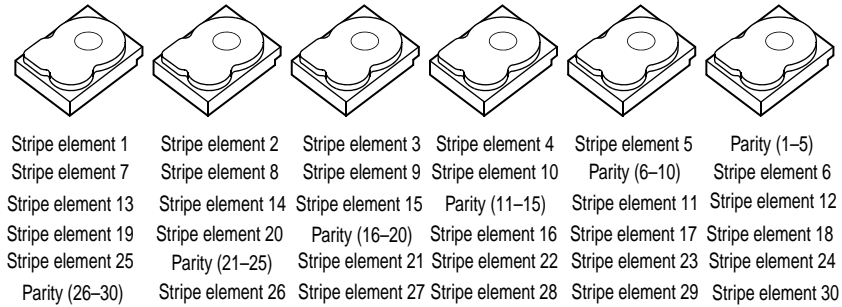

 **NOTE:** Parity is distributed across multiple physical disks in the disk group.

**Figure 2-4. Example of Dual Distributed Parity (RAID 6)**

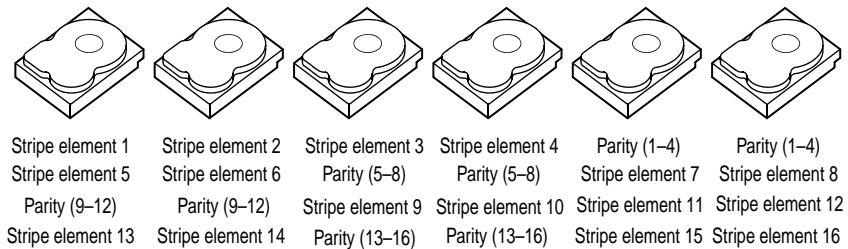

 **NOTE:** Parity is distributed across all drives in the array.

# About PERC 6 and CERC 6i Controllers

This section describes the features of the Dell™ PowerEdge™ Expandable RAID Controller (PERC) 6 and Dell Cost-Effective RAID Controller (CERC) 6/i family of controllers, such as the configuration options, disk array performance, redundant array of independent disks (RAID) management utilities, and operating system software drivers.

## PERC 6 and CERC 6i Controller Features

Table 3-1 compares the hardware configurations for the PERC 6 and CERC 6/i controllers.

**Table 3-1. PERC 6 and CERC 6/i Controller Comparisons**

<b>Specification</b>	<b>PERC 6/E Adapter</b>	<b>PERC 6/i Adapter</b>	<b>PERC 6/i Integrated</b>	<b>CERC 6/i Integrated</b>
RAID Levels	0, 1, 5, 6, 10, 50, 60	0, 1, 5, 6, 10, 50, 60	0, 1, 5, 6, 10, 50, 60	0 and 1
Enclosures per Port	Up to 3 enclosures	N/A	N/A	N/A
Ports	2 x4 external wide port	2 x4 internal wide port	2 x4 internal wide port	1 x4 internal wide port
Processor	LSI adapter SAS RAID-on-Chip, 8-port with 1078	LSI adapter SAS RAID-on-Chip, 8-port with 1078	LSI adapter SAS RAID-on-Chip, 8-port with 1078	LSI adapter SAS RAID-on-Chip, 8-port with 1078
Battery Backup Unit	Yes, Transportable	Yes <sup>a</sup>	Yes	No

**Table 3-1. PERC 6 and CERC 6/i Controller Comparisons (continued)**

<b>Specification</b>	<b>PERC 6/E Adapter</b>	<b>PERC 6/i Adapter</b>	<b>PERC 6/i Integrated</b>	<b>CERC 6/i Integrated</b>
Cache Memory	256-MB DDRII cache memory size  Optional 512-MB DIMM	256-MB DDRII cache memory size	256-MB DDRII cache memory size	128-MB DDRII cache memory size
Cache Function	Write-Back, Write-Through, Adaptive Read Ahead, No-Read Ahead, Read Ahead	Write-Back, Write-Through, Adaptive Read Ahead, No-Read Ahead, Read Ahead	Write-Back, Write-Through, Adaptive Read Ahead, No-Read Ahead, Read Ahead	Write-Back, Write-Through, Adaptive Read Ahead, No-Read Ahead, Read Ahead
Maximum Number of Spans per Disk Group	Up to 8 arrays	Up to 8 arrays	Up to 8 arrays	N/A
Maximum Number of Virtual Disks per Disk Group	Up to 16 virtual disks per disk group for non-spanned RAID levels: 0, 1, 5, and 6.  One virtual disk per disk group for spanned RAID levels: 10, 50, and 60.	Up to 16 virtual disks per disk group for non-spanned RAID levels: 0, 1, 5, and 6.  One virtual disk per disk group for spanned RAID levels: 10, 50, and 60.	Up to 16 virtual disks per disk group for non-spanned RAID levels: 0, 1, 5, and 6.  One virtual disk per disk group for spanned RAID levels: 10, 50, and 60.	Up to 16 virtual disks per disk group  RAID 0=16 RAID 1=16
Multiple Virtual Disks per Controller	Up to 64 virtual disks per controller	Up to 64 virtual disks per controller	Up to 64 virtual disks per controller	Up to 64 virtual disks per controller

**Table 3-1. PERC 6 and CERC 6/i Controller Comparisons (continued)**

<b>Specification</b>	<b>PERC 6/E Adapter</b>	<b>PERC 6/i Adapter</b>	<b>PERC 6/i Integrated</b>	<b>CERC 6/i Integrated</b>
Support for x8 PCI Express host interface	Yes	Yes	Yes	Yes
Online Capacity Expansion	Yes	Yes	Yes	Yes
Dedicated and Global Hot Spares	Yes	Yes	Yes	Yes
Hot Swap Devices Supported	Yes	Yes	Yes	Yes
Non-Disk Devices Supported	No	No	No	No
Enclosure Hot-Add <sup>b</sup>	Yes	N/A	N/A	N/A
Mixed Capacity Physical Disks Supported	Yes	Yes	Yes	Yes
Hardware Exclusive-OR (XOR) Assistance	Yes	Yes	Yes	Yes

**Table 3-1. PERC 6 and CERC 6/i Controller Comparisons (continued)**

Specification	PERC 6/E Adapter	PERC 6/i Adapter	PERC 6/i Integrated	CERC 6/i Integrated
Reversible Hot Spares Supported	Yes	Yes	Yes	N/A
Redundant Path Support	Yes	N/A	N/A	N/A

<sup>a</sup> The PERC 6/i adapter supports a battery backup unit (BBU) on selected systems only. For additional information, see the documentation that shipped with the system.

<sup>b</sup> Using the enclosure Hot-Add feature you can hot plug enclosures to the PERC 6/E adapter without rebooting the system.

 **NOTE:** The maximum array size is limited by the maximum number of drives per disk group (32), the maximum number of spans per disk group (8), and the size of the physical drives.

 **NOTE:** The number of physical disks on a controller is limited by the number of slots in the backplane on which the card is attached.

## Using the SMART Feature

The Self-Monitoring Analysis and Reporting Technology (SMART) feature monitors the internal performance of all motors, heads, and physical disk electronics to detect predictable physical disk failures. The SMART feature helps monitor physical disk performance and reliability.

SMART-compliant physical disks have attributes for which data (values) can be monitored to identify changes in values and determine whether the values are within threshold limits. Many mechanical and electrical failures display some degradation in performance before failure.



A SMART failure is also referred to as a predicted failure. There are numerous factors that relate to predicted physical disk failures, such as a bearing failure, a broken read/write head, and changes in spin-up rate. In addition, there are factors related to read/write surface failure, such as seek error rate and excessive bad sectors. For information on physical disk status, see "Disk Roaming" on page 27.



**NOTE:** For detailed information on Small Computer System Interface (SCSI) interface specifications, see [www.t10.org](http://www.t10.org) and for detailed information on for Serial Attached ATA (SATA) interface specifications, see [www.t13.org](http://www.t13.org).

## Initializing Virtual Disks

You can initialize the virtual disks in four ways as described in the following sections.

### Background Initialization

Background Initialization (BGI) is an automated process that writes the parity or mirror data on newly created virtual disks. BGI assumes that the data is correct on all new drives. BGI does not run on RAID 0 virtual disks.



**NOTE:** You cannot permanently disable BGI. If you cancel BGI, it automatically restarts within five minutes. For information on stopping BGI, see "Stopping Background Initialization" on page 107.

The BGI rate is controlled by the Open Manage storage management software. After you have changed the BGI rate in Open Manage storage management software, the change does not take effect until the next BGI is run.



**NOTE:** Unlike full or fast initialization of virtual disks, background initialization does not clear data from the physical disks.

Consistency Check (CC) and BGI perform similar functions in that they both correct parity errors. However, Consistency Check reports data inconsistencies through an event notification, but BGI does not (BGI assumes the data is correct, as it is run only on a newly created disk). You can start Consistency Check manually, but not Background Initialization.

## Full Initialization of Virtual Disks

Performing a full initialization on a virtual disk overwrites all blocks and destroys any data that previously existed on the virtual disk. A full initialization eliminates the need for that virtual disk to undergo a background initialization and can be performed directly after the creation of a virtual disk.

During full initialization, the host is not be able to access the virtual disk. You can start a full initialization on a virtual disk by using the **Slow Initialize** option in the Dell OpenManage Storage Management application. To use the BIOS Configuration Utility to perform a full initialization, see "Initializing Virtual Disks" on page 88.



**NOTE:** If the system is rebooted during a full initialization, the operation aborts and a BGI begins on the virtual disk.

## Fast Initialization of Virtual Disks

A fast initialization on a virtual disk overwrites the first and last 8 MB of the virtual disk, clearing any boot records or partition information. This operation takes only 2-3 seconds to complete and is recommended when recreating virtual disks. To perform a fast initialization using the BIOS Configuration Utility, see "Initializing Virtual Disks" on page 88.

## Consistency Checks

Consistency Check is a background operation that verifies and corrects the mirror or parity data for fault tolerant virtual disks. It is recommended that you periodically run a consistency check on virtual disks.

You can manually start a consistency check using the BIOS Configuration Utility or a Open Manage storage management application. To start a consistency check using the BIOS Configuration Utility, see "Checking Data Consistency" on page 88. Consistency checks can be scheduled to run on virtual disks using a Open Manage storage management application.

By default, consistency check automatically corrects mirror or parity inconsistencies. However, you can enable the **Abort Consistency Check on Error** feature on the controller using Dell™ OpenManage™ Storage Management. With the **Abort Consistency Check on Error** setting enabled, consistency check notifies if any inconsistency is found and aborts instead of automatically correcting the error.

## Disk Roaming

The PERC 6 and CERC 6/i adapters support moving physical disks from one cable connection or backplane slot to another on the same controller. The controller automatically recognizes the relocated physical disks and logically places them in the proper virtual disks that are part of the disk group. You can perform disk roaming only when the system is turned off.

 **CAUTION: Do not attempt disk roaming during RAID level migration (RLM) or capacity expansion (CE). This causes loss of the virtual disk.**

Perform the following steps to use disk roaming:

- 1 Turn off the power to the system, physical disks, enclosures, and system components, and then disconnect the power cords from the system.
- 2 Move the physical disks to different positions on the backplane or the enclosure.
- 3 Perform a safety check. Make sure the physical disks are inserted properly.
- 4 Turn on the system.

The controller detects the RAID configuration from the configuration data on the physical disks.

## Disk Migration

The PERC 6 and CERC 6/i controllers support migration of virtual disks from one controller to another without taking the target controller offline. However, the source controller must be offline prior to performing the disk migration. The controller can import RAID virtual disks in optimal, degraded, or partially degraded states. You cannot import a virtual disk that is in an offline state.



**NOTE:** The PERC 6 controllers are not backward compatible with previous Small Computer System Interface (SCSI), PowerEdge Expandable RAID Controller (PERC), and Redundant Array of Independent Disks (RAID) controllers.

When a controller detects a physical disk with a pre-existing configuration, it flags the physical disk as *foreign*, and it generates an alert indicating that a foreign disk was detected.

 **CAUTION:** Do not attempt disk roaming during RLM or CE. This causes loss of the virtual disk.

Perform the following steps to use disk migration.

- 1 Turn off the system that contains the source controller.
- 2 Move the appropriate physical disks from the source controller to the target controller.

The system with the target controller can be running while inserting the physical disks.

The controller flags the inserted disks as foreign disks.

- 3 Use the Open Manage storage management application to import the detected foreign configuration.

 **NOTE:** Ensure that all physical disks that are part of the virtual disk are migrated.

 **NOTE:** You can also use the controller BIOS configuration utility to migrate disks.

## Compatibility With Virtual Disks Created on PERC 5 Controllers

Virtual disks that were created on the PERC 5 family of controllers can be migrated to the PERC 6 and CERC 6i controllers without risking data or configuration loss. Migrating virtual disks from PERC 6 and CERC 6i controllers to PERC 5 is not supported.

 **NOTE:** For more information about compatibility, contact your Dell Technical Support Representative.

Virtual disks that were created on the CERC 6/i controller or the PERC 5 family of controllers can be migrated to PERC 6.

## Compatibility With Virtual Disks Created on SAS 6/iR Controllers

The migration of virtual disks created on the SAS 6/iR family of controllers can be migrated to PERC 6 and CERC 6i. However, only virtual disks with boot volumes of the following Linux operating systems successfully boot after migration:

- Red Hat Enterprise Linux 4 Update 5
- Red Hat Enterprise Linux 5
- SUSE Linux Enterprise Server 10 (64-bit)



**NOTE:** The migration of virtual disks with Microsoft Windows operating systems is not supported.



**NOTICE:** Before migrating virtual disks, back up your data and ensure that the firmware of both controllers is the latest revision. Also ensure that you use the SAS 6 firmware version 00.25.41.00.06.22.01.00 or later version.

## Migrating Virtual Disks from SAS 6/iR to PERC 6 and CERC 6i



**NOTE:** The supported operating systems listed above contain a driver for the PERC 6 and CERC 6i controller family. No additional drivers are needed during the migration process.



- 1 If virtual disks with one of the supported Linux operating systems listed above are being migrated, open a command prompt and type the following commands:

```
modprobe megaraid_sas  
  
mkinitrd -f --preload megaraid_sas /boot/initrd-`uname  
-r`.img `uname -r`
```

- 2 Turn off the system.
- 3 Move the appropriate physical disks from the SAS 6/iR controller to the PERC 6 and CERC 6i. If you are replacing your SAS 6/iR controller with a PERC 6, see the *Hardware Owner's Manual* that came with your system.



**CAUTION:** After you have imported the foreign configuration on the PERC 6 or CERC 6i storage controllers, you cannot migrate the storage disks back to the SAS 6/iR controller as it may result in the loss of data.

- 4 Boot the system and import the foreign configuration that is detected. You can do this in two ways as described below:
    - Press <F> to automatically import the foreign configuration
    - Enter the **BIOS Configuration Utility** and navigate to the **Foreign Configuration View**
-  **NOTE:** For more information on **BIOS Configuration Utility**, see "Entering the BIOS Configuration Utility" on page 79.
-  **NOTE:** For more information on **Foreign Configuration View**, see "Foreign Configuration View" on page 103
- 5 If the migrated virtual disk is the boot volume, ensure that the virtual disk is selected as the bootable volume for the target PERC 6 and CERC 6i controller. See "Controller Management Actions" on page 103.
  - 6 Exit the **BIOS Configuration Utility** and reboot the system.
  - 7 Ensure that all the latest drivers available on the Dell support website at support.dell.com for PERC 6 or CERC 6/i controller are installed. For more information, see "Installing the Drivers" on page 63.
-  **NOTE:** For more information about compatibility, contact your Dell Technical Support Representative.

## Battery Management

 **NOTE:** Battery management is only applicable to PERC 6 family of controllers.

The Transportable Battery Backup Unit (TBBU) is a cache memory module with an integrated battery pack that enables you to transport the cache module with the battery into a new controller. The TBBU protects the integrity of the cached data on the PERC 6/E adapter by providing backup power during a power outage.

The Battery Backup Unit (BBU) is a battery pack that protects the integrity of the cached data on the PERC 6/i adapter and PERC 6/i Integrated controllers by providing backup power during a power outage.

The battery may provide up to 72 hours for a 256-MB controller cache memory backup power and up to 48 hours for a 512-MB cache when new.

## Battery Warranty Information

The BBU offers an inexpensive way to protect the data in cache memory. The lithium-ion battery provides a way to store more power in a smaller form factor than previous batteries.

The BBU shelf life has been preset to last six months from the time of shipment without power. To prolong battery life:

- Deploy the BBU within six months of ship date.
- Do not store or operate the BBU above 60°C.
- Disconnect the BBU if the system is going to be turned off (power disconnected) for longer than one week.

Your PERC 6 battery may provide up to 24 hours of controller cache memory backup power when new. Under the 1-year limited warranty, we warrant that the battery will provide at least 24 hours of backup coverage during the 1-year limited warranty period.

## Battery Learn Cycle

Learn cycle is a battery calibration operation performed by the controller periodically to determine the condition of the battery. This operation cannot be disabled.

You can start battery learn cycles manually or automatically. In addition, you can enable or disable automatic learn cycles in the software utility. If you enable automatic learn cycles, you can delay the start of the learn cycles for up to 168 hours (7 days). If you disable automatic learn cycles, you can start the learn cycles manually, and you can choose to receive a reminder to start a manual learn cycle.

You can put the learn cycle in **Warning Only** mode. In the **Warning** mode, a warning event is generated to prompt you to start the learn cycle manually when it is time to perform the learn cycle operation. You can select the schedule for initiating the learn cycle. When in **Warning** mode, the controller continues to prompt you to start the learn cycle every seven days until it is performed.



**NOTE:** Virtual disks automatically switch to **Write-Through** mode when the battery charge is low because of a learn cycle.

## Learn Cycle Completion Time Frame

The time frame for completion of a learn cycle is a function of the battery charge capacity and the discharge/charge currents used. For PERC 6, the expected time frame for completion of a learn cycle is approximately seven hours and consists of the following parts:

- Learn cycle discharge cycle: approximately three hours
- Learn cycle charge cycle: approximately four hours

Learn cycles shorten as the battery capacity deteriorates over time.



**NOTE:** For additional information, see the OpenManage storage management application.

During the discharge phase of a learn cycle, the PERC 6 battery charger is disabled and remains disabled until the battery is discharged. After the battery is discharged, the charger is re-enabled.

## Virtual Disk Write Cache Policies

The write cache policy of a virtual disk determines how the controller handles writes to that virtual disk. **Write-Back** and **Write-Through** are the two write cache policies and can be set on a virtual disk basis.

### Write-Back and Write-Through

In **Write-Through** caching, the controller sends a data transfer completion signal to the host system when the disk subsystem has received all the data in a transaction.

In **Write-Back** caching, the controller sends a data transfer completion signal to the host when the controller cache has received all the data in a transaction. The controller then writes the cached data to the storage device in the background.

The risk of using **Write-Back** cache is that the cached data can be lost if there is a power failure before it is written to the storage device. This risk is mitigated by using a BBU on selected PERC 6 controllers. For information on which controllers support a BBU, see Table 3-1.

**Write-Back** caching has a performance advantage over **Write-Through** caching.



**NOTE:** The default cache setting for virtual disks is **Write-Back** caching.



**NOTE:** Certain data patterns and configurations perform better with a **Write-Through** cache policy.



## Conditions Under Which Write-Back is Employed

Write-Back caching is used under all conditions in which the battery is present and in good condition.

## Conditions Under Which Write-Through is Employed

Write-Through caching is used under all conditions in which the battery is missing or in a low-charge state. Low-charge state is when the battery is not capable of maintaining data for at least 24 hours in the case of a power loss.

## Conditions Under Which Forced Write-Back With No Battery is Employed

Write-Back mode is available when the user selects **Force WB with no battery**. When Forced **Write-Back** mode is selected, the virtual disk is in Write-Back mode even if the battery is not present.



**CAUTION: It is recommended that you use a power backup system when forcing Write-Back to ensure that there is no loss of data if the system suddenly loses power.**

## Virtual Disk Read Policies

The read policy of a virtual disk determines how the controller handles reads to that virtual disk. Some read policies are:

- **Always Read Ahead - Read-Ahead** capability allows the controller to read sequentially ahead of requested data and to store the additional data in cache memory, anticipating that the data is required soon. This speeds up reads for sequential data, but there is little improvement when accessing random data.
- **No Read Ahead** - Disables the **Read-Ahead** capability.
- **Adaptive Read Ahead** - When selected, the controller begins using **Read-Ahead** if the two most recent disk accesses occurred in sequential sectors. If the read requests are random, the controller reverts to **No read ahead**.

# Reconfiguring Virtual Disks

There are two different methods to reconfigure RAID virtual disks — RAID Level Migration and Online Capacity Expansion. RAID Level Migrations (RLM) involve the conversion of a virtual disk to a different RAID level and Online Capacity Expansions (OCE) refer to increasing the capacity of a virtual disk by adding drives and/or migrating to a different RAID level. When a RLM/OCE operation is complete and reboot is not necessary. For a list of possible RAID level migrations and whether or not a capacity expansion is possible in that scenario, see Table 3-2.

The source RAID level column indicates the virtual disk level before the RAID level migration and the target RAID level column indicates the RAID level after the operation is complete.

 **NOTE:** If you configure 64 virtual disks on a controller, you cannot perform a RAID level migration or capacity expansion on any of the virtual disks.

 **NOTE:** The controller changes the write cache policy of all virtual disks undergoing a RLM/OCE to Write-Through until the RLM/OCE is complete.

**Table 3-2. RAID Level Migration**

Source RAID Level	Target RAID Level	Required Number of Physical Disks (Beginning)	Number of Physical Disks (End)	Capacity Expansion Possible	Description
RAID 0	RAID 1	1	2	No	Converting non-redundant virtual disk into a mirrored virtual disk by adding one drive.
RAID 0	RAID 5	1 or more	3 or more	Yes	At least one drive needs to be added for distributed parity data.
RAID 0	RAID 6	1 or more	4 or more	Yes	At least two drives need to be added for dual distributed parity data.
RAID 1	RAID 0	2	2	Yes	Removes redundancy while doubling capacity.

**Table 3-2. RAID Level Migration (continued)**

<b>Source RAID Level</b>	<b>Target RAID Level</b>	<b>Required Number of Physical Disks (Beginning)</b>	<b>Number of Physical Disks (End)</b>	<b>Capacity Expansion Possible</b>	<b>Description</b>
RAID 1	RAID 5	2	3 or more	Yes	Removes redundancy while doubling capacity.
RAID 1	RAID 6	2	4 or more	Yes	Two drives are required to be added for distributed parity data.
RAID 5	RAID 0	3 or more	2 or more	Yes	Converting to a non-redundant virtual disk and reclaiming disk space used for distributed parity data.
RAID 5	RAID 6	3 or more	4 or more	Yes	At least one drive needs to be added for dual distributed parity data.
RAID 6	RAID 0	4 or more	2 or more	Yes	Converting to a non-redundant virtual disk and reclaiming disk space used for distributed parity data.
RAID 6	RAID 5	4 or more	3 or more	Yes	Removing one set of parity data and reclaiming disk space used for it.



**NOTE:** The total number of physical disks in a disk group cannot exceed 32.



**NOTE:** You cannot perform RAID level migration and expansion on RAID levels 10, 50, and 60.

# Fault Tolerance Features

Table 3-3 lists the features that provide fault tolerance to prevent data loss in case of a failed physical disk.

**Table 3-3. Fault Tolerance Features**

Specification	PERC	CERC
Support for SMART	Yes	Yes
Support for Patrol Read	Yes	Yes
Redundant path support	Yes	N/A
Physical disk failure detection	Automatic	Automatic
Physical disk rebuild using hot spares	Automatic	Automatic
Parity generation and checking (RAID 5, 50, 6, and 60 only)	Yes	N/A
Battery backup of controller cache to protect data	Yes <sup>a</sup>	N/A
Manual learn cycle mode for battery backup	Yes	N/A
Detection of batteries with low charge after bootup	Yes	N/A
Hot-swap manual replacement of a physical disk without reboot	Yes	Yes

<sup>a</sup> The PERC 6/i adapter supports a BBU on selected systems only. For additional information, see the documentation that was shipped with the system.

## Physical Disk Hot Swapping

Hot swapping is the manual substitution of a replacement unit in a disk subsystem for a defective one. The manual substitution can be performed while the subsystem is performing its normal functions.

 **NOTE:** The system backplane or enclosure must support hot swapping in order for the PERC 6 and CERC 6/i controllers to support hot swapping.

 **NOTE:** Ensure that SAS drives are replaced with SAS drives, and SATA drives are replaced with SATA drives.

 **NOTE:** While swapping a disk, ensure that the new disk is of equal or greater capacity than the disk that is being replaced.

## Failed Physical Disk Detection

The controller automatically detects and rebuilds failed physical disks when a new drive is placed in the slot where the failed drive resided or when an applicable hot spare is present. Automatic rebuilds can be performed transparently with hot spares. If you have configured hot spares, the controllers automatically try to use them to rebuild failed physical disks.

## Redundant Path With Load Balancing Support

The PERC 6/E adapter can detect and use redundant paths to drives contained in enclosures. This provides the ability to connect two SAS cables between a controller and an enclosure for path redundancy. The controller is able to tolerate the failure of a cable or enclosure management module (EMM) by utilizing the remaining path.

When redundant paths exist, the controller automatically balances I/O load through both paths to each disk drive. This load balancing feature increases throughput to each drive and is automatically turned on when redundant paths are detected. To set up your hardware to support redundant paths, see "Setting up Redundant Path Support on the PERC 6/E Adapter" on page 56.



**NOTE:** This support for redundant paths refers to path-redundancy only and not to controller-redundancy.

## Using Replace Member and Reversible Hot Spares

The **Replace Member** functionality allows a previously commissioned hot spare to be reverted back to a usable hot spare. When a drive failure occurs within a virtual disk, an assigned hot spare (dedicated or global) is commissioned and begins rebuilding until the virtual disk is optimal. After the failed drive is replaced (in the same slot) and the rebuild to the hot spare is complete, the controller automatically starts to copy data from the commissioned hot spare to the newly-inserted drive. After the data is copied, the new drive is part of the virtual disk and the hot spare is reverted back to being a ready hot spare; this allows hot spares to remain in specific enclosure slots. While the controller is reverting the hot spare, the virtual disk remains optimal.



**NOTE:** The controller automatically reverts a hot spare only if the failed drive is replaced with a new drive in the same slot. If the new drive is not placed in the same slot, a manual **Replace Member** operation can be used to revert a previously commissioned hot spare.

## Automatic Replace Member with Predicted Failure

A **Replace Member** operation can occur when there is a SMART predictive failure reporting on a drive in a virtual disk. The automatic **Replace Member** is initiated when the first SMART error occurs on a physical disk that is part of a virtual disk. The target drive needs to be a hot spare that qualifies as a rebuild drive. The physical disk with the SMART error is marked as **failed** only after the successful completion of the **Replace Member**. This avoids putting the array in degraded status.

If an automatic **Replace Member** occurs using a source drive that was originally a hot spare (that was used in a rebuild), and a new drive added for the **Replace Member** operation as the target drive, the hot spare reverts to the hot spare state after a successful **Replace Member** operation.



**NOTE:** To enable the automatic Replace Member, use the Dell OpenManage Storage Management. For more information on automatic Replace Member, see "Dell OpenManage Storage Management" on page 77.



**NOTE:** For information on manual Replace Member, see "Replacing an Online Physical Disk" on page 106.

## Patrol Read

The **Patrol Read** feature is designed as a preventative measure to ensure physical disk health and data integrity. **Patrol Read** scans for and resolves potential problems on configured physical disks. The Open Manage storage management application can be used to start **Patrol Read** and change its behavior.

### Patrol Read Feature

The following is an overview of **Patrol Read** behavior:

- 1 **Patrol Read** runs on all disks on the controller that are configured as part of a virtual disk including hot spares.
- 2 **Patrol Read** does not run on unconfigured physical disks. Unconfigured disks are those that are not part of a virtual disk or are in **Ready** state.

- 3 **Patrol Read** adjusts the amount of controller resources dedicated to **Patrol Read** operations based on outstanding disk I/O. For example, if the system is busy processing I/O operation, then **Patrol Read** uses fewer resources to allow the I/O to take a higher priority.
- 4 **Patrol Read** does not run on any disks that are involved in any of the following operations:
  - Rebuild
  - Replace Member
  - Full or Background Initializations
  - Consistency Check
  - RAID Level Migration or Online Capacity Expansion

### **Patrol Read Modes**

The following describes each of the modes **Patrol Read** can be set to:

- **Auto** (default)- **Patrol Read** is set to the Auto mode by default. This means that it is enabled to run automatically and start every seven days. You can start and stop **Patrol Read** as well.
- **Manual** - **Patrol Read** does not run automatically. You must start the **Patrol Read** manually when the **Manual** mode is set.
- **Disabled** - **Patrol Read** is not allowed to start on the controller.





# Installing and Configuring Hardware

 **CAUTION:** Only trained service technicians are authorized to remove the system cover and access any of the components inside the system. Before performing any procedure, refer to the safety and warranty information that shipped with your system for complete information about safety precautions, working inside the computer, and protecting against electrostatic discharge.

 **CAUTION:** Electrostatic discharge can damage sensitive components. Always use proper antistatic protection when handling components. Touching components without using a proper ground can damage the equipment.

## Installing the PERC 6/E and PERC 6/i Adapters

- 1 Unpack the PERC 6/E adapter and check for damage.

 **NOTE:** Contact Dell Technical support if the controller is damaged.

- 2 Turn off the system and attached peripherals, and disconnect the system from the electrical outlet. For more information on power supplies, refer to your system's *Hardware Owner's Manual*.
- 3 Disconnect the system from the network and remove the system cover. For more information on opening the system, refer to your system's *Hardware Owner's Manual*.
- 4 Select an empty PCI Express (PCI-E) slot. Remove the blank filler bracket on the back of the system aligned with the PCI-E slot you have selected.
- 5 Align the PERC 6/E adapter to the PCI-E slot you have selected.

 **CAUTION:** Never apply pressure to the memory module while inserting the controller into the PCI-E slot. Applying pressure could break the module

- 6 Insert the controller gently, but firmly, until the controller is firmly seated in the PCI-E slot. For more information on PERC 6 adapter, see Figure 4-1. For more information on PERC 6/i adapter, see Figure 4-2.

 **NOTE:** For a list of compatible controllers, see the documentation that shipped with the system.

**Figure 4-1. Installing a PERC 6/E Adapter**

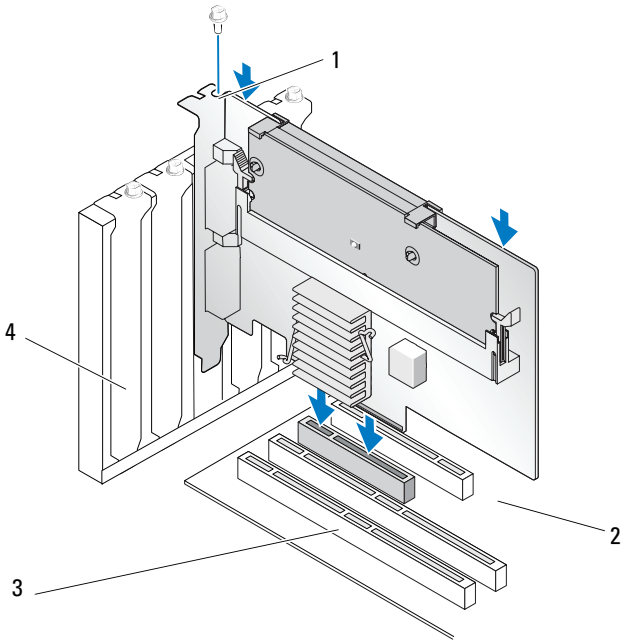

1 bracket screw

2 PERC 6/i adapter

3 PCI-e slot

4 filler brackets

**Figure 4-2. Installing a PERC 6/i Adapter**

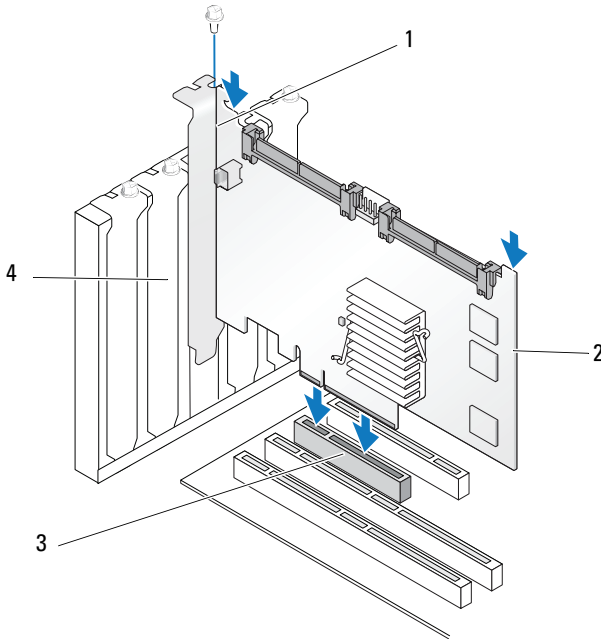

- |   |                  |   |                 |
|---|------------------|---|-----------------|
| 1 | bracket screw    | 3 | PCI-e slot      |
| 2 | PERC 6/i adapter | 4 | filler brackets |

- 7** Tighten the bracket screw, if any, or use the system's retention clips to secure the controller to the system's chassis.
- 8** For PERC 6/E adapter, replace the cover of the system. For more information on closing the system, refer to your system's *Hardware Owner's Manual*.

- 9 Connect the cable from the external enclosure to the controller.  
See Figure 4-3.

**Figure 4-3. Connecting the Cable From the External Enclosure**

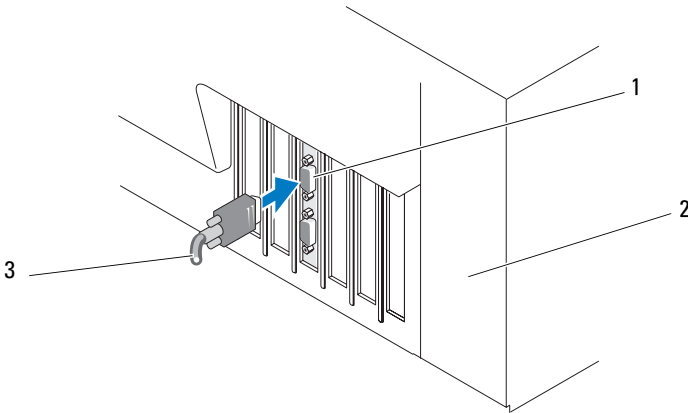

- |                               |                                     |
|-------------------------------|-------------------------------------|
| 1 connector on the controller | 3 cable from the external enclosure |
| 2 system                      | 4 memory module                     |

- 10 For PERC 6/i adapter, connect the cables from the backplane of the system to the controller. The primary SAS connector is white and the secondary SAS connector is black. See Figure 4-4.

**Figure 4-4. Connecting Cables to the Controller**

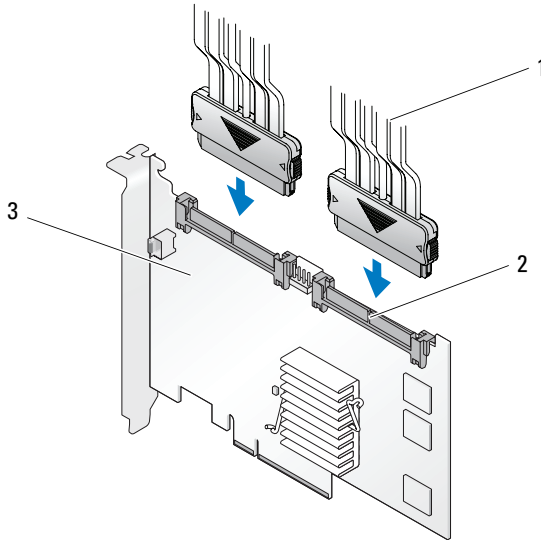

- |   |            |   |                  |
|---|------------|---|------------------|
| 1 | cable      | 3 | PERC 6/i adapter |
| 2 | connectory | 4 | memory module    |

- 11 Replace the cover of the system. For more information on closing the system, see your system's *Hardware Owner's Manual*.
- 12 Reconnect the power cable(s) and network cables, and turn on the system.

## Installing the Transportable Battery Backup Unit (TBBU) for PERC 6/E

This section describes the installation of the transportable battery backup unit (TBBU) on the PERC 6/E.

**⚠ CAUTION:** The following procedure must be performed at an Electrostatic Discharge (ESD)-safe workstation to meet the requirements of EIA-625 - "Requirements For Handling Electrostatic Discharge Sensitive Devices." The following procedure must be performed following the IPC-A-610 latest revision ESD recommended practices.

- 1 Unpack the TBBU and follow all antistatic procedures.
- ➔ **NOTICE:** When transporting a sensitive component, first place it in an antistatic container or packaging.
-  **NOTE:** Handle all sensitive components in a static-safe area. If possible, use antistatic floor pads and work bench pads.
- 2 With the DIMM removed from the controller, insert one end of the battery pack harness (the red, white, yellow, and green wires) into the connector on the memory module and the other end into the connector on the battery.
- 3 Place the top edge of the battery over the top edge of the memory module so that the arms on the side of the battery fit into their sockets on the memory module. See Figure 4-5.

**Figure 4-5. Installing a TBBU**

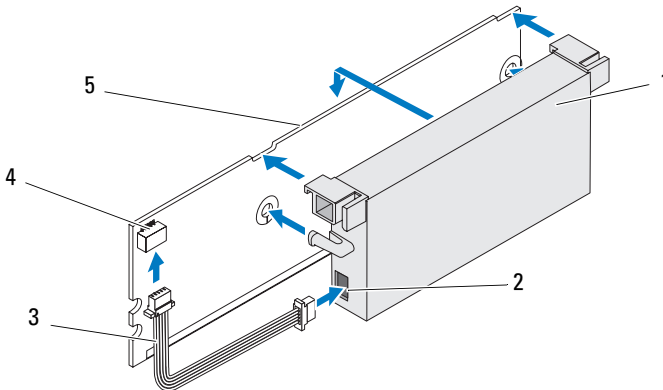

- |                            |                                  |
|----------------------------|----------------------------------|
| 1 battery                  | 4 connector on the memory module |
| 2 connector on the battery | 5 memory module                  |
| 3 battery pack harness     |                                  |

- 4 Place the PERC 6/E adapter on a flat, clean, static-free surface.

- 5 Mount the memory module in the controller memory socket like a standard DIMM. For more information, see "Installing the DIMM on a PERC 6/E Adapter" on page 47.

The memory module is mounted flush with the board so that the memory module is parallel to the board when installed.

- 6 Press the memory module firmly into the memory socket.

As you press the memory module into the socket, the TBBU clicks into place, indicating that the controller is firmly seated in the socket, and the arms on the socket fit into the notches to hold the memory module securely.

## Installing the DIMM on a PERC 6/E Adapter

This section describes how to install the memory module on a PERC 6/E adapter.

 **NOTICE:** PERC 6 cards support Dell-qualified 512-MB and 256-MB DDRII 667MHz ECC-registered DIMMs with x16 DRAM components. Installing unsupported memory causes the system to hang at POST.

- 1 Remove the memory module in an antistatic environment.

 **NOTE:** When unpacking a static sensitive component from its shipping carton, do not remove the component from the antistatic packing material until you are ready to install the component. Before unwrapping the antistatic package, ensure to discharge static electricity from your body.

 **NOTE:** Handle all sensitive components in a static-safe area. If possible, use antistatic floor pads and work bench pads.

 **NOTE:** Do not touch the gold leads and do not bend the memory module.

- 2 Align the memory module so that the keyed edge of the memory module is placed exactly on top of the physical divider on the memory socket of the controller to avoid damage to the DIMM.
- 3 Insert the memory module on the memory socket of the controller and apply a smooth, downward pressure on both ends or on the middle of the memory module until the retention clips fall into the allotted slots on either side of the memory module. See Figure 4-6.

Figure 4-6 displays the installation of a memory module on a PERC 6/E adapter.

**Figure 4-6. Installing a DIMM**

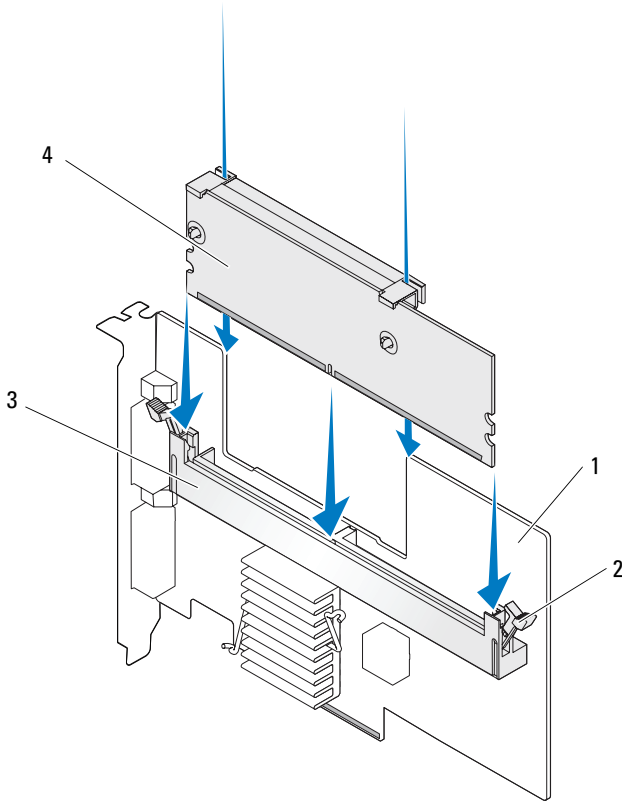

- 1 PERC 6/E adapter
- 2 retention clip

- 3 memory socket
- 4 memory module



## Transferring a TBBU Between Controllers

The TBBU provides uninterrupted power supply to the memory module for up to 72 hours (for a 256 MB of controller cache memory) backup power and up to 48 hours (for a 512 MB cache) if power supply is unexpectedly interrupted while cached data is still present. If the controller fails as a result of a power failure, you can move the TBBU to a new controller and recover the data. The controller that replaces the failed controller must be devoid of any prior configuration.

Perform the following steps to replace a failed controller with data in the TBBU:

- 1** Perform a controlled shutdown on the system in which the PERC 6/E is installed, as well as any attached storage enclosures.
- 2** Remove the controller that has the TBBU currently installed from the system.
- 3** Remove the TBBU from the controller.
- 4** Insert the TBBU into the new controller.

See "Replace the cover of the system. For more information on closing the system, see your system's Hardware Owner's Manual." on page 45.

- 5** Insert the new controller into the system.

See the relevant sections on installing controllers under "Installing the PERC 6/E and PERC 6/i Adapters" on page 41.

- 6** Turn on the system.

The controller flushes the cache data to the virtual disks.

## Removing the PERC 6/E and PERC 6/i Adapters

 **NOTE:** In the event that the SAS cable is accidentally pulled when the system is operational, reconnect the cable and see the online help of your Open Manage storage management application for the required recovery steps.

 **NOTE:** Some PERC 6/i adapters installed on a Dell workstation or Dell SC systems do not have a BBU.

- 1 Perform a controlled shutdown on the system in which the PERC 6/E is installed, as well as any attached storage enclosures.
- 2 Disconnect the system from the electrical outlet and remove the system cover.



**CAUTION:** Running a system without the system cover installed may cause damage due to improper cooling.



**NOTE:** For more information on removing and reinstalling the system cover, refer to the *Hardware Owner's Manual* that shipped with the system.

- 3 For removing a PERC 6/E adapter, locate the PERC 6/E in the system and disconnect the external cables from the PERC 6/E.
- 4 Remove any retention mechanism such as a bracket screw that may be holding the PERC 6/E in the system and gently lift the controller from the system's PCI-E slot. See Figure 4-7.

**Figure 4-7. Removing the PERC 6/E Adapter**

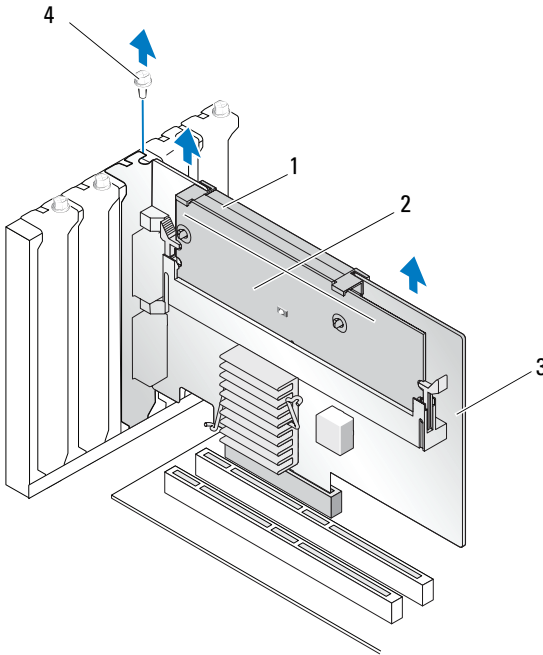

- |   |               |   |                  |
|---|---------------|---|------------------|
| 1 | battery       | 3 | PERC 6/E adapter |
| 2 | memory module | 4 | bracket screw    |

**NOTE:** For more information on removing peripherals installed in the system's PCI-E slots, see the *Hardware Owner's Manual* that shipped with the system.

- For removing a PERC 6/i adapter, determine whether the dirty cache LED on the controller is illuminated.
  - If the LED is illuminated, replace the system cover, reconnect the system to power, turn on the system, and repeat [step 1](#) and [step 2](#). See [Figure 4-8](#).

**NOTE:** The location of the PERC 6/i varies from system to system. For information on PERC 6/i card location, see the *Hardware Owner's Manual* that shipped with the system.

- If the LED is not illuminated, continue with the next step.

**Figure 4-8. Removing the PERC 6/i Adapter**

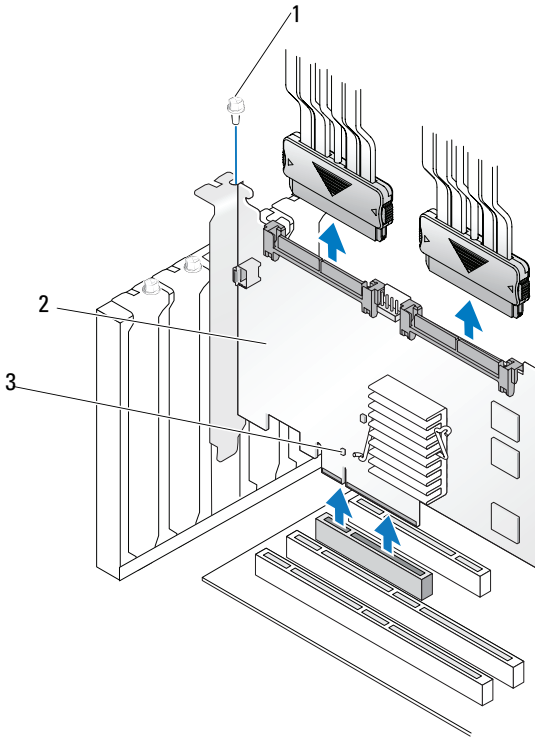

1 bracket screw

3 Dirty Cache LED location

2 PERC 6/i

- 6 Disconnect the data cables and battery cable from the PERC 6/i. Remove any retention mechanism, such as a bracket screw, that might be holding the PERC 6/i in the system, and gently lift the controller from the system's PCI-E slot.



**NOTE:** For more information on removing the PERC 6/i adapter from the system, see your system's *Hardware Owner's Manual*.

# Removing the DIMM and Battery from a PERC 6/E Adapter

 **NOTE:** The TBBU on the PERC 6/E adapter consists of a DIMM and battery backup unit.

This section describes how to remove the TBBU from a PERC 6/E adapter that is currently installed in a system.

- 1 Perform a controlled shutdown on the system in which the PERC 6/E adapter is installed, as well as any attached storage enclosures, and remove the PERC 6/E adapter from the system by following the instructions detailed in "Removing the PERC 6/E and PERC 6/i Adapters" on page 50.
- 2 Visually inspect the controller and determine whether the dirty cache LED on the DIMM is illuminated. See Figure 4-9. If the LED is illuminated, reinsert the controller into the system, replace the system cover, reconnect the system to power, turn the system on and repeat [step 1](#).

**Figure 4-9. PERC 6/E Adapter Dirty Cache LED Location**

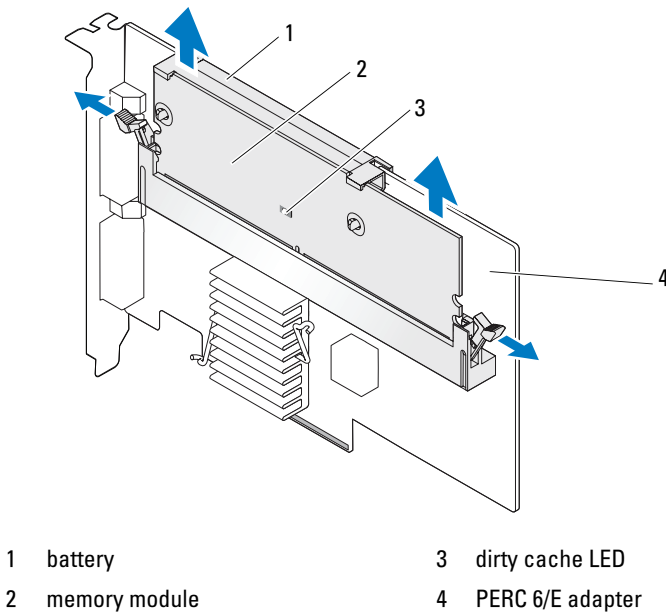

**⚠ CAUTION: Running a system without the system cover installed can cause damage due to improper cooling.**

- 3 Remove the TBBU assembly from the adapter by pressing down on the tabs at each edge of the DIMM connector and lifting the TBBU off the adapter.
- 4 Disconnect the battery cable from the DIMM.
- 5 Detach the battery from the DIMM by pressing out on the battery clips inserted through the DIMM and rotating the battery off the DIMM. See Figure 4-10.

**Figure 4-10. Removing the TBBU**

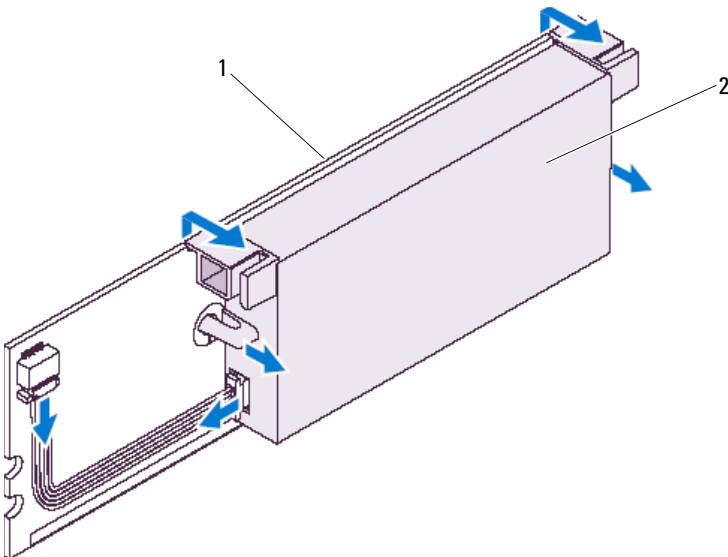

1 memory module

2 battery

# Disconnecting the BBU from a PERC 6/i Adapter or a PERC 6/i Integrated Controller

 **NOTE:** A PERC 6/i adapter installed in a Dell workstation or a Dell SC system does not have a BBU.

 **NOTE:** Batteries with low charges can be detected and recharged. The battery must first be charged and the system must be restarted for the battery to be active again.

This section describes how to disconnect the BBU on a PERC 6/i adapter or a PERC 6/i Integrated controller while the adapter or controller is installed in a system.

- 1 Perform a controlled shutdown on the system in which the PERC 6/i is installed.
- 2 Disconnect the system from the electrical outlet and remove the system cover.

 **CAUTION:** Running a system without the system cover installed can cause damage due to improper cooling.

 **NOTE:** For more information on removing and replacing the system cover, refer to the *Hardware Owner's Manual* that shipped with the system.

- 3 Determine whether the dirty cache LED on the controller is illuminated.
  - If the LED is illuminated, replace the system cover, reconnect the system to power, turn on the system, and repeat [step 1](#) and [step 2](#).
    -  **NOTE:** The location of the PERC 6/i varies from system to system. For information on PERC 6/i card location, see the *Hardware Owner's Manual* that shipped with the system.
  - If the LED is not illuminated, continue with the next step.
- 4 Locate the battery cable connection on the controller and disconnect the battery.

# Setting up Redundant Path Support on the PERC 6/E Adapter

The PERC 6/E adapter can detect and use redundant paths to drives contained in enclosures. With redundant paths to the same port of a device, if one path fails, another path can be used to communicate between the controller and the device. For more information about redundant paths, see "Redundant Path With Load Balancing Support" on page 37.

To set up a configuration with redundant paths, both ports on a controller must be cabled to the IN ports of a single enclosure.

To add multiple enclosures, both OUT ports of the first enclosure must be cabled to the IN ports of the next enclosure.

If the connection between an OUT port on the controller and an IN port on an enclosure fails, an alternate path exists through the second OUT port on the controller and the second In port on the enclosure. For more information, see Figure 4-11, Figure 4-12 and Figure 4-13.

 **NOTE:** The PERC 6/E adapter supports redundant paths when used with Dell PowerVault MD1000 and Dell PowerVault MD1120 disk storage enclosures.

Figure 4-11 displays Redundant path Storage Configuration with one enclosure.

**Figure 4-11. Redundant Path Support Configuration With One Enclosure**

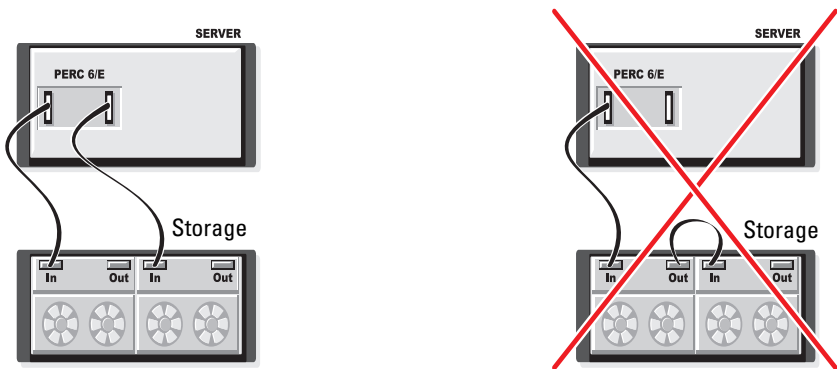



Figure 4-12 displays Redundant path Storage Configuration with two enclosures.

**Figure 4-12. Redundant Path Support Configuration With Two Enclosures**

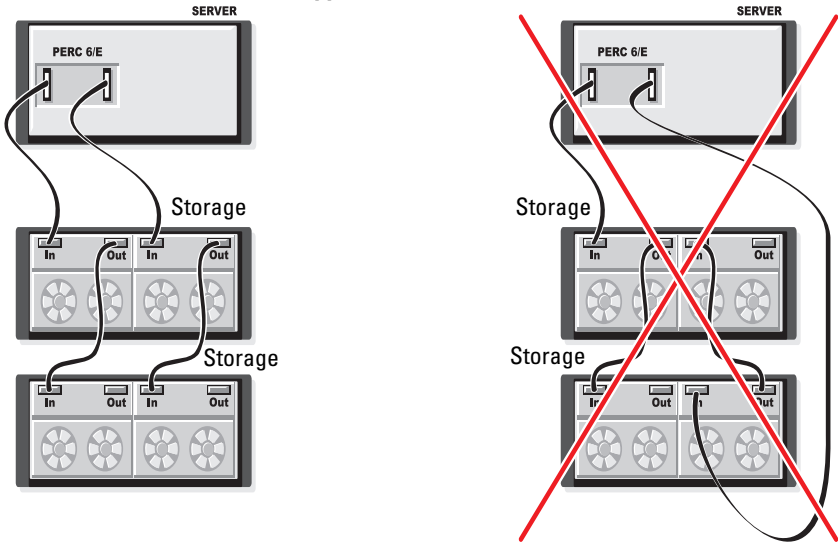
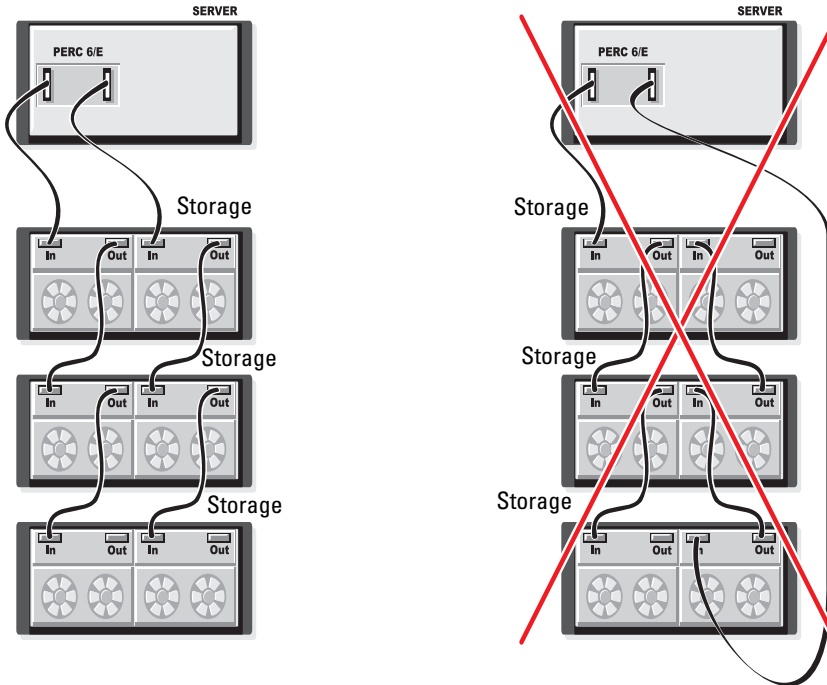



Figure 4-13 displays Redundant path Storage Configuration with three enclosures

**Figure 4-13. Redundant Path Support Configuration With Three Enclosures**



A single PERC 6/E adapter can support up to three disk storage enclosures in a redundant path configuration.

 **NOTE:** Ensure that the latest firmware version is installed on your storage controller. You can download the latest firmware from the Dell Support website at [support.dell.com](http://support.dell.com) and flash it to the firmware on the controller. For the latest firmware installation instructions, see the system documentation located on the Dell Support website at [support.dell.com](http://support.dell.com).

Perform the following steps to configure the hardware to utilize redundant paths on the PERC 6/E adapter:

- 1 Set up an enclosure on the PERC 6/E adapter.
- 2 Connect two SAS cables from the OUT ports on your PERC 6/E adapter to the IN ports of the external enclosure. See Figure 4-3 to view the connection of the cables from the external enclosure to the PERC 6/E adapter.



**NOTE:** For information on Unified Mode, see the enclosure documentation that was shipped with the system.

- 3 To add multiple enclosures, cable both OUT ports of the first enclosure to both IN ports of the next enclosure.

After you set up the hardware, the controller detects the redundant paths and automatically utilizes them to balance the I/O load.

## Removing and Installing the CERC 6/i Modular Storage Controller Card (Service-Only Procedure)

The Modular Storage Controller Card is located below the hard drive bays of the Dell Modular

Blade system. To remove the Modular Storage Controller Card:

- 1 Remove the Dell Modular Blade system from the Modular blade system chassis. For more information on removing the blade system from the Modular Blade system chassis, see your system's *Hardware Owner's Manual* or the *User's Guide*.
- 2 Remove the system cover of the Modular blade system. For more information on opening the top cover of the Modular blade system, see your system's *Hardware Owner's Manual* or the *User's Guide*.
- 3 Remove the system board and place it on a stable, flat work surface. For more information on removing the system board, see your system's *Hardware Owner's Manual* or the *User's Guide*.

- 4 Open the release lever to disconnect the Modular Storage Controller Card edge connector from the system board connector as illustrated in Figure 4-14.
  - 5 Lift the Modular Storage Controller Card straight up from the system board as illustrated in Figure 4-14.
- ➔ **NOTICE:** Do not apply pressure to the internal SAS port connectors as they could be damaged.
- ➔ **NOTICE:** Electrostatic discharge can damage sensitive components. Always use proper antistatic protection when handling components. Touching components without using a proper ground can damage the equipment.

**Figure 4-14. Removing and Installing the Storage Controller Card**

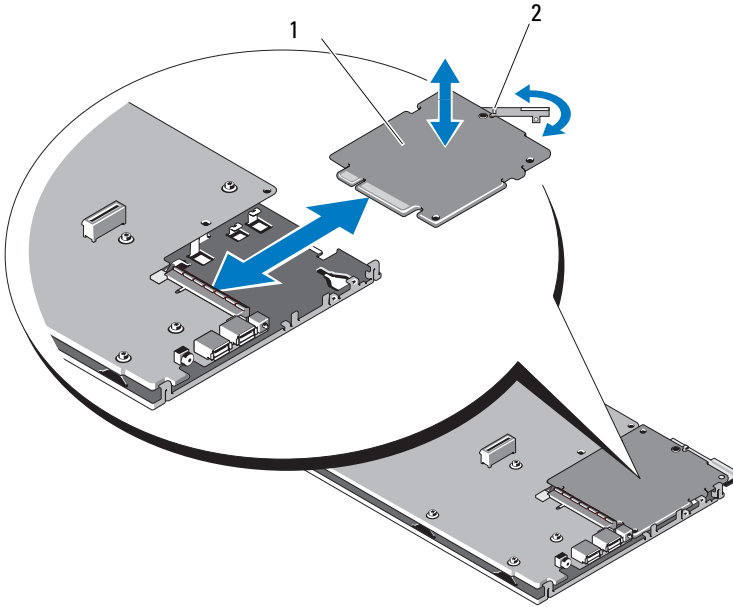

1 storage controller card

2 release lever

## Installing the Modular Storage Controller Card

To install your new CERC 6/i Modular Storage Controller:

- 1 Unpack the new CERC 6/i Modular Storage Controller Card and check for damage.



**NOTE:** If the card is damaged, contact Dell.

- 2 Place the Modular Storage Controller Card onto the System Board. Place by aligning the Modular Storage Controller Card such that the tabs on the metal System Board tray fit through the notches in the edges of the Modular Storage Controller Card.
- 3 Slide the Modular Storage Controller Card towards the connector on the System Board until the Modular Storage Controller Card's edge connector clicks into place.
- 4 Reinstall the System Board. For more information on reinstalling the System Board, see your system's Hardware Owner's Manual or the User's Guide.
- 5 Close the top cover of the Modular blade system. For more information on closing the top cover of the Modular blade system, see your system's Hardware Owner's Manual or the User's Guide.
- 6 Reinstall the Modular blade system in the Modular blade system chassis. For more information on reinstalling the Modular blade system into the Modular blade system chassis, see your system's Hardware Owner's Manual or the User's Guide.



**NOTE:** The CERC 6/i Modular does not provide support for a battery backup unit.



**NOTE:** For the latest list of firmware and driver installation instructions, see the system documentation located at the Dell Support website at [support.dell.com](http://support.dell.com).



# Installing the Drivers

The Dell™ PowerEdge™ Expandable RAID Controller (PERC) 6 and Dell Cost-Effective RAID Controller (CERC) 6/i family of controllers require software drivers to operate with the supported operating systems.

This chapter contains the procedures for installing the drivers for the following operating systems.

- Citrix® XenServer Dell Edition
- Microsoft® Windows® Server® 2003
- Microsoft Windows XP
- Microsoft Windows Vista™
- Microsoft Windows Server 2008 (including Hyper-V virtualization)
- Novell® NetWare® 6.5
- Red Hat® Enterprise Linux™ Version 4 Update 5 and Red Hat Enterprise Linux Version 5
- Solaris™ 10 Update 5 (64-bit)
- SUSE® Linux Enterprise Server Version 9 SP4 (64-bit) and SUSE Linux Enterprise Server Version 10 (64-bit)
- VMware® ESX 3.5 and 3.5i



**NOTE:** For more information on Citrix XenServer and VMware ESX drivers, refer to the Citrix XenServer and VMware ESX documentation respectively.



**NOTE:** To check operating system compatibility, refer to the Dell Support website at [support.dell.com](http://support.dell.com).

The two methods for installing a driver that are discussed in this chapter are:

- During operating system installation—Use this method if you are performing a new installation of the operating system and want to include the drivers.
- Updating existing drivers—Use this method if the operating system and PERC 6 and CERC 6i family of controllers are already installed and you want to update to the latest drivers.

# Installing Windows Driver

This section documents the procedures used to install the Windows driver.

## Creating the Driver Media

Perform the following steps to create the driver media:

- 1 Browse to the download section for the system from the Dell Support website at [support.dell.com](http://support.dell.com).
- 2 Locate and download the latest PERC 6 controller driver to the system.
- 3 Follow the instructions on the Dell Support website for extracting the driver to the media.

## Pre-Installation Requirements

Before you install the operating system:

- Read the Microsoft *Getting Started* document that ships with your operating system.
- Ensure that your system has the latest BIOS, firmware, and driver updates. If required, download the latest BIOS, firmware, and driver updates from the Dell Support website at [support.dell.com](http://support.dell.com).
- Create a device driver media (diskette, USB drive, CD, or DVD).

## Creating the Device Driver Media

Use one of the following two methods to create the device driver media.

### ***Downloading Drivers From the Dell Systems Service and Diagnostic Tools Media***

- 1 Insert the *Dell Systems Service and Diagnostics Tools* media into a system. The **Welcome to Dell Service and Diagnostic Utilities** screen is displayed.
- 2 Select your system model and operating system (Microsoft Windows Server 2008).
- 3 Click **Continue**.



- 4 From the list of drivers displayed, select the driver that you require. Select the self-extracting zip file and click **Run**. Copy the driver to a diskette drive, CD, DVD, or USB drive. Repeat this step for all the drivers that you require.
- 5 During the operating system installation described in "Installing the Driver During a Windows Server 2003 or Windows XP Operating System Installation" on page 66, "Installing the Driver During a Windows Server 2008 or Windows Vista Installation" on page 66 and "Installing a Windows Server 2003, Windows Server 2008, Windows Vista, or Windows XP Driver for a New RAID Controller" on page 67, use the media that you created with the **Load Driver** option to load mass storage drivers.

### ***Downloading Drivers From the Dell Support Site***

- 1 Go to [support.dell.com](http://support.dell.com).
- 2 Click **Drivers and Downloads**.
- 3 Enter the service tag of your system in the **Choose by Service Tag** field or select your system's model.
- 4 Select the **System Type, Operating System, Driver Language, and Category** from the drop-down list.
- 5 The drivers that are applicable to your selection are displayed. From the available list, download the drivers that you require to a diskette drive, USB drive, CD, or DVD.
- 6 During the operating system installation described in "Installing the Driver During a Windows Server 2003 or Windows XP Operating System Installation" on page 66 and "Installing the Driver During a Windows Server 2003 or Windows XP Operating System Installation" on page 66, use the media that you created with the **Load Driver** option to load mass storage drivers.

## Installing the Driver During a Windows Server 2003 or Windows XP Operating System Installation

Perform the following steps to install the driver during operating system installation.

- 1 Boot the system using the Microsoft Windows XP/Microsoft Windows Server 2003 media.

- 2 When the message **Press F6 if you need to install a third party SCSI or RAID driver** appears, press the <F6> key immediately.

Within a few minutes, a screen appears that asks for additional controllers in the system.

- 3 Press the <S> key.

The system prompts for the driver media to be inserted.

 **NOTE:** The driver can be provided using a properly formatted USB key. For additional details on the driver, go the Dell Support website at [support.dell.com](http://support.dell.com).

- 4 Insert the driver media in the media drive and press <Enter>.

A list of PERC 6 and CERC 6i controllers appears.

- 5 Select the right driver for the installed controller and press <Enter> to load the driver.

 **NOTE:** For Windows Server 2003, a message may appear that states that the driver that you provided is older or newer than the existing Windows driver. Press <S> to use the driver that is on the media.

- 6 Press <Enter> again to continue the installation process as usual.

## Installing the Driver During a Windows Server 2008 or Windows Vista Installation

Perform the following steps to install the driver during operating system installation.

- 1 Boot the system using the Microsoft Windows Vista/Microsoft Windows Server 2008 media.

- 2 Follow on-screen instructions until you reach **Where do you want to install Vista/2008** and select **Load driver...**

- 3 The system prompts for the media to be inserted. Insert the installation media and browse to the proper location.
- 4 Select the appropriate PERC 6 controller from the list, click **Next** and continue installation.



**NOTE:** Windows Server 2008 and Windows Vista operating systems include native support for the PERC 6 and CERC 6i RAID controller. The driver is automatically installed. For driver updates, see the **Drivers and Downloads** section on the Dell Support website at [support.dell.com](http://support.dell.com).

### **Installing a Windows Server 2003, Windows Server 2008, Windows Vista, or Windows XP Driver for a New RAID Controller**



**NOTE:** PERC 5 and PERC 6 use the same driver and do not require separate driver installations.

Perform the following steps to configure the driver for the RAID controller on a system that already has Windows installed.

- 1 Turn off the system.
- 2 Install the new RAID controller in the system.

For detailed instructions on installing and cabling the RAID controller in the system, see "Installing and Configuring Hardware" on page 41.

- 3 Turn on the system.

The Windows operating system detects the new controller and displays a message to inform the user.

- 4 The **Found New Hardware Wizard** screen pops up and displays the detected hardware device.



**NOTE:** Windows 2008 and Vista include a device driver to support the PERC adapters. The system automatically detects the new controller and installs the driver. Check the version of the driver installed by Windows and update if required.

- 5 Click **Next**.
- 6 On the **Locate device driver** screen, select **Search for a suitable driver for my device** and click **Next**.
- 7 Make the Driver Files available and browse to the proper location from the **Locate Driver Files** screen.

- 8 Click **Next**.
- 9 The wizard detects and installs the appropriate device drivers for the new RAID controller.
- 10 Click **Finish** to complete the installation.
- 11 Reboot the system when prompted.

## **Updating an Existing Windows Server 2003, Windows Server 2008, Windows XP, or Windows Vista Driver**

Perform the following steps to update the Microsoft Windows driver for the PERC 6 controller already installed on your system.

 **NOTE:** It is important that you close all applications on your system before you update the driver.

- 1 Select **Start**→ **Settings**→ **Control Panel**→ **System**.

The **System Properties** screen appears.

 **NOTE:** For systems running a Windows Server 2003 operating system, click **Start**→ **Control Panel**→ **System**.

- 2 Click on the **Hardware** tab.
- 3 Click **Device Manager**.

The **Device Manager** screen appears.

 **NOTE:** An alternative method is to open **Device Manager**. In **Windows Explorer**, right click **My Computer**→ **Manage**. The **Computer Management** window launches. Select **Device Manager**.

- 4 Double-click on **SCSI and RAID Controllers**.

 **NOTE:** In **Windows 2008** and **Windows Vista**, **PERC** is listed under **Storage Controllers**.

- 5 Double-click the RAID controller for which you want to update the driver.
- 6 Click the **Driver** tab and click **Update Driver**.  
The **Upgrade Device Driver Wizard** screen appears.
- 7 Make the driver files available with the USB key or other media.
- 8 Select **Install from a list or specific location**.
- 9 Click **Next**.

- 10 Follow the steps in the wizard and browse to the location of the driver files.
- 11 Select the INF file from the USB key or other media.
- 12 Click **Next** and continue the installation steps in the Wizard.
- 13 Click **Finish** to exit the wizard and reboot the system for the changes to take place.



**NOTE:** Dell provides the Dell Update Package (DUP) to update drivers on systems running Windows Server 2003 and Windows Server 2008. DUP is an executable application that updates drivers for specific devices. DUP supports command line interface and silent execution. For more information, go to the Dell Support website at [support.dell.com](http://support.dell.com).

## Installing Linux Driver

Use the procedures in this section to install the driver for Linux. The driver is updated frequently. To ensure that you have the current version of the driver, download the updated Linux driver from the Dell Support website at [support.dell.com](http://support.dell.com).

### Creating a Driver Diskette

Before beginning the installation, copy the drivers from the *Service and Diagnostic Utilities* media or download the driver appropriate for Linux from the Dell Support website at [support.dell.com](http://support.dell.com). This file includes two Red Hat Package Managers (RPMs) and driver update disk files. The package also contains the Dynamic Kernel Module Support (DKMS) Red Hat Package Manager (RPM) file, source code, and release notes.

For more information on DKMS, see the Dell Support website at [support.dell.com](http://support.dell.com).

The package is a gzipped **tar** file. After downloading the package to a Linux system, perform the following steps.

- 1 Unzip the package using `gunzip`.
- 2 Untar the file using `tar -xvf`.

- 3 Use the `dd` command to create a driver update disk. Use the appropriate image for the purpose.

```
dd if=<name of the dd image file> of=/dev/fd0
```

 **NOTE:** You can create a driver update disk on a Windows system using the program `dcopynt`.

 **NOTE:** The output file of might be different, depending on how your operating system maps the diskette drive. You do not need to mount the diskette drive in order to execute the `dd` command.

- 4 Use the diskette for operating system installation as described later in this section.

### Creating a Driver Update Diskette Using DKMS

Perform the following steps to create the Driver Update Diskette (DUD) using the DKMS tool:

 **NOTE:** To work, the driver must be installed on the system where this procedure is performed.

- 1 Install the DKMS-enabled `megaraid_sas` driver rpm package.
- 2 Type the following command in any directory:

```
dkms mkdriverdisk -m megaraid_sas -v <driver version> -k <kernel version> -d <distro>
```

 **NOTE:** The values for the `-d` option are `suse` for Suse Linux Enterprise Server diskettes and `redhat` for RHEL diskettes.

 **NOTE:** For further information on usage of DKMS, see the DKMS main page.

This starts the process to create the `megaraid_sas` DUD image. After the DUD image has been built, you can find it in the DKMS tree for the `megaraid_sas` driver. See the output of the `dkms mkdriverdisk` command for the exact path.

## Installing Red Hat Enterprise Linux Operating Systems using the Driver Update Diskette

Perform the following steps to install Red Hat Enterprise Linux (versions 4 and 5) and the appropriate driver.

- 1 Boot normally from the Red Hat Enterprise Linux installation media.
- 2 At the command prompt, type:  

```
linux expert dd
```
- 3 When the install prompts for a driver diskette, insert the diskette and press <Enter>. For information about creating a driver diskette, see "Creating a Driver Diskette" on page 69.
- 4 Complete the installation as directed by the installation program. The driver is installed.

## Installing SUSE Linux Enterprise Server Using the Driver Update Diskette

 **NOTE:** For information about creating a driver diskette, see "Creating a Driver Diskette" on page 69.

To install SUSE Linux Enterprise Server (version 9 or 10) using the DUD:

- 1 Insert the appropriate SUSE Linux Enterprise Server (version 9 or 10) Service Pack media in the system.
- 2 Select <F5> for the driver update disk.  
 **NOTE:** If you are installing Suse Linux Enterprise Server 10, press <F5>. If you are installing Suse Linux Enterprise Server 9, press <F6>.
- 3 Select **Installation** from the menu.
- 4 Press <Enter> to load the Linux kernel.
- 5 At the prompt `Please insert the driver update floppy`, click **OK**.

The system selects the driver from the diskette and installs it. The system then displays the message

`DRIVER UPDATE ADDED` with the description of the driver module.

**6** Click OK.

If you want to install from another driver update medium, continue with the following steps.

**7** The system displays the message `PLEASE CHOOSE DRIVER UPDATE MEDIUM`.

**8** Select the appropriate driver update medium.

The system selects the driver from the disk and installs it.



**NOTE:** Suse Linux Enterprise Server 9 Gold media is required when you install any Suse Linux Enterprise Server 9 service pack.

## Installing the RPM Package With DKMS Support

Perform the following steps to install the RPM package with DKMS support:

**1** Uncompress the gzipped tarball driver release package.

**2** Install the DKMS package using the command: `rpm -ihv dkms-<version>.noarch.rpm`

**3** Install the driver package using the command: `rpm -ihv megaraid_sas-<version>.noarch.rpm`



**NOTE:** Use `rpm -Uvh <package name>` when updating an existing package.

**4** If the previous device driver is in use, you must reboot the system for the updated driver to take effect.

**5** Verify that the driver has been loaded.

## Upgrading the Kernel

When upgrading to a new kernel, you must reinstall the DKMS-enabled driver packages. Perform the following steps to update or install the driver for the new kernel:

**1** In a terminal window, type the following:

```
dkms build -m <module_name> -v <module version>
-k <kernel version>
```

```
dkms install -m <module_name> -v <module version>
-k <kernel version>
```



- 2 To check whether the driver is successfully installed in the new kernel, type:

```
dkms status
```

You must see a message similar to the following one on the screen to confirm installation:

```
<driver name>, <driver version>, <new kernel version>: installed
```

- 3 If the previous device driver is in use, you must reboot the system for the updated driver to take effect.

## Installing Solaris Driver

Use the procedures in this section to install the driver for Solaris 10. To ensure that you have the current version of the driver, download the updated Solaris driver from the Dell Support website at [support.dell.com](http://support.dell.com).

The package is a gzipped `.tar` file. Download the package to a Solaris system, and perform the following steps:

- 1 Extract the package contents: 

```
gunzip -c <driver_package.tgz> | tar xvf -
```
- 2 Use the `dd` command to create a driver update disk. Use the appropriate image for the purpose. Type: 

```
dd if=./mega_sas.img of= /<diskette drive device node> bs=32k
```

 **NOTE:** If you are uncertain which device node corresponds to your diskette drive, execute the `rmformat` command and search for the correct **Logical Node**.

 **NOTE:** You can create a DUD on a system running the Windows operating system using the program `dcopynt`.

- 3 If you prefer, you may use the `cdrecord` command to create a CDROM instead of a floppy image. Type: 

```
cdrecord dev=<bus>,<target>,<lun> mega_sas_cd.iso
```

 **NOTE:** To identify the correct location of the bus, Target, and logical unit number (LUN) combination, execute the following command:

```
cdrecord --scanbus
```

## Installing Solaris 10 on a PowerEdge System Booting From a PERC 6 and CERC 6i Controller

To install the driver during Solaris 10 operating system installation:

- 1 Boot the system from the Solaris installation media and select the preferred console.
- 2 After Solaris finishes configuring devices, a menu appears. Select **Apply Driver Updates**.
- 3 Select [1] if you created a CD from the `mega_sas_cd.iso` file.
- 4 Select [2] if you created a diskette from the `mega_sas.img` file and you are using a traditional diskette drive.
- 5 Select [3] if you created a diskette from the `mega_sas.img` file and you are using a removable (USB) diskette drive.
- 6 Follow instructions presented by **Driver Update** installer.
- 7 The `The Installation of <meegasas> was successful` message appears.
- 8 Select [e] to end
- 9 Follow the instructions on the screen to complete installation.

### Adding/Updating the Driver to an Existing System

- 1 To add the `mega_sas` driver to an existing system, or to upgrade to a newer version of the driver, you must unarchive the driver package and execute the installation script:

```
tar xvf x86_64.tar
cd x86_64
./install.sh
```

- 2 Restart your Solaris system to start using the new driver. To confirm the `mega_sas` driver is loaded, run the following command:  
`modinfo | grep mega_sas`
- 3 Ensure that the driver version is correct.

# Installing NetWare Driver

Use the procedures in this section to install the driver for Novell NetWare 6.5. To ensure that you have the current version of the driver, download the updated NetWare driver from the Dell Support website at [support.dell.com](http://support.dell.com).

## Installing the NetWare Driver in a New NetWare System

Follow the instructions in the *Novell NetWare Installation Guide* to install Novell NetWare in the system. Perform the following steps to install Novell NetWare using the SAS RAID controller as a primary adapter:

- 1 Boot from the Novell NetWare media.
- 2 Follow the instructions on the screen until you reach the **Device Driver** screen, which is used to modify drivers.
- 3 Select **Modify**, and press <Enter>.
- 4 From the screen that displays, go to the **Storage Adapter** screen to install the MegaRAID SAS driver.
- 5 Delete any existing RAID adapter listings.
- 6 Press <Insert> to add unlisted drivers.
- 7 Press <Insert> again.  
A path is displayed.
- 8 Press <F3>.
- 9 Insert the driver diskette into the diskette drive, and press <Enter>.  
The system finds the .HAM driver.
- 10 Press <Tab>.
- 11 Select the **Driver Summary** screen, and press <Enter>.
- 12 Continue the Novell NetWare installation procedure.

## Installing or Updating the NetWare Driver in an Existing NetWare System

Perform the following steps to add the Novell NetWare driver to an existing installation:

- 1** At the root prompt, type **hdetect** and press <Enter>. The **Configuration Options** screen is displayed.
- 2** From the screen that displays, go to the **Storage Adapter** screen to install the MegaRAID SAS driver.
- 3** Delete any existing RAID adapter listings.
- 4** Press <Insert> to add unlisted drivers.
- 5** Press <Insert> again. A path is displayed.
- 6** Press <F3>.
- 7** Insert the driver diskette into the diskette drive, and press <Enter>. The system finds the **.HAM** driver.
- 8** Press <Tab>.
- 9** Select the Driver Summary screen, and press <Enter>.
- 10** Continue the Novell NetWare installation procedure.

# Configuring and Managing RAID

Dell Open Manage storage management applications enable you to manage and configure the RAID system, create and manage multiple disk groups, control and monitor multiple RAID systems, and provide online maintenance. The applications for Dell™ PowerEdge™ Expandable RAID Controller (PERC) 6 controllers include:

- Dell™ OpenManage™ Storage Management
- Dell SAS RAID Storage Manager
- BIOS Configuration Utility (Ctrl+R)

## Dell OpenManage Storage Management

Dell OpenManage Storage Management is a storage management application for Dell systems that provides enhanced features for configuring a system's locally-attached RAID and non-RAID disk storage. Dell OpenManage Storage Management enables you to perform controller and enclosure functions for all supported RAID controllers and enclosures from a single graphical or command-line interface without requiring the use of the controller BIOS utilities. The graphical user interface (GUI) is wizard-driven with features for novice and advanced users and detailed online help. Using Dell OpenManage Storage Management, you can protect your data by configuring data-redundancy, assigning hot spares, or rebuilding failed physical disks. The command line interface available on selected operating systems to perform RAID management tasks is fully featured and scriptable.

## Dell SAS RAID Storage Manager

SAS RAID Storage Manager is a storage management application for Dell SC systems and Dell Precision™ workstations. SAS RAID Storage Manager configures virtual disks, and monitors and maintains PERC 6 controllers, battery backup units, and other devices running on systems and workstations. It offers a graphical user interface (GUI) you can use to perform these tasks.

# RAID Configuration Functions

 **NOTE:** Dell OpenManage Storage Management can perform all the same tasks as and more tasks than the BIOS Configuration Utility.

After you attach physical disks, use a configuration utility to organize your SAS drives and SATA drives into virtual disks. If the operating system is not yet installed, use the BIOS Configuration Utility to perform this procedure.

 **NOTE:** The PERC 6 controllers support Dell-qualified SATA physical disks.

Use the configuration utilities to perform the following tasks:

- Access controllers, virtual disks, and physical disks individually
- Select a host controller to work on
- Create hot spare physical disks
- Configure virtual disks
- Initialize one or more virtual disks
- Perform consistency checks
- Rebuild failed physical disks
- Preserve the cache data, known as pinned cache, from a virtual disk that goes offline or is deleted for any reason

The following sections describe the menu options and provide detailed instructions used to perform the configuration tasks. They apply to the BIOS Configuration Utility. The following is a list of the procedures used to configure physical disks into virtual disks.

- 1 Define virtual disks using a group of physical disks.

 **NOTE:** A disk group is deleted when the last virtual disk in the disk group is deleted.

- 2 Designate hot spares (optional).

For more information, see "Managing Dedicated Hot Spares" on page 94.

- 3 Save the configuration information.

- 4 Initialize the virtual disks.

For the detailed configuration procedures, see "Physical Disk Management" on page 104.

# BIOS Configuration Utility

The BIOS Configuration Utility, also known as Ctrl+R, is a Open Manage storage management application embedded on the PERC 6 controllers that configures and maintains RAID disk groups and virtual disks, and manages the RAID system. Ctrl+R is independent of any operating system.



**NOTE:** Use the BIOS Configuration Utility for initial setup and disaster recovery. You can set Advanced features through Dell OpenManage Storage Management and Dell SAS RAID Storage Manager.

The following sections provide information about using the BIOS Configuration Utility. See the online help option by pressing <F1> to obtain additional information about the ongoing operation.



**NOTE:** The PERC 6 controller configuration utility refreshes the screen to show changes to information on the screen. The refresh occurs when you press a key or every 15 seconds if you do not press a key.

## Entering the BIOS Configuration Utility

The BIOS Configuration Utility configures physical disk groups and virtual disks. Because the utility resides in the controller BIOS, its operation is independent of the operating systems on your system.

Perform the following steps to enter the BIOS Configuration Utility when you boot the system.

- 1 Turn on and boot the system.

A BIOS banner displays information about the controller and configuration.

- 2 During bootup, press <Ctrl><R> when prompted by the BIOS banner. After you press <Ctrl><R>, if there is only one controller, the **Virtual Disk Management** screen for that controller displays. If there is more than one controller, the main menu screen displays first. This screen lists the RAID controllers. Use the arrow keys to select the RAID controller you want to configure, and press <Enter> to access the management menus for the controller. The virtual disks, physical disks, free space, hot spares, and other items displays in the other menu screens. The information can display in a list view or in an expandable tree directory similar to that of Microsoft® Windows® Explorer.

 **NOTE:** You can access multiple controllers through the BIOS Configuration Utility by pressing <F12>.

 **NOTE:** You can access PERC 5 and PERC 6 adapters from the same BIOS if the PERC 5 firmware version is 5.1.1-0040 or later. You need to verify if you are currently set to edit the PERC 5 or PERC 6 adapter.

## Exiting the Configuration Utility

To exit the BIOS Configuration Utility, press <Esc> at any menu screen. If there is only one controller, then a dialog box displays to confirm your choice. Select **OK to exit** and press <Enter>.

If multiple controllers are present, then the <Esc> key brings you to the **Controller Selection** screen. Press <Esc> again to reach the exit screen. A dialog box displays to confirm your choice. Select **OK to exit** and press <Enter>.

## Menu Navigation Controls

Table 6-1 displays the menu keys you can use to move between the different screens in the BIOS Configuration Utility.

**Table 6-1. Menu Navigation Keys**

Notation	Meaning and Use	Example
→	Use the right arrow key to open a submenu, move from a menu heading to the first submenu, or move to the first item in that submenu. If you press the right arrow key at a menu heading, the submenu expands. Press it again to go to the first item in the submenu. The right arrow key is also used to close a menu list in a popup window. Word wrap is supported.	Start → Programs
←	Use the left arrow key to close a submenu, move from a menu item to the menu heading for that item, or move from a submenu to a higher level menu. If you press the left arrow key at a menu heading, the submenu collapses. Press it again to go to the higher-level menu. Word wrap is supported.	Controller 0 ← Disk Group 1



**Table 6-1. Menu Navigation Keys (continued)**

<b>Notation</b>	<b>Meaning and Use</b>	<b>Example</b>
↑	Use the up arrow key to move to the upper menu items within a menu or to a higher level menu. You can also use the up arrow key to close a menu list in a popup window, such as the stripe element size menu. Word wrap is supported.	Virtual Disk 1 ↑ Virtual Disk 4
↓	Use the down arrow key to move to the lower menu items within a menu or to a lower level menu. You can also use the down arrow key to open a menu list in a popup window, such as the stripe element size menu, and select a setting. Word wrap is supported.	Virtual Disks ↓ Virtual Disk 1
Underlined letter in a menu heading on the menu bar	Indicates a shortcut you can use by pressing <Alt><underlined letter>. To use this feature, the menu must be activated. Menu shortcuts are allowed but cannot be used when a menu is active.	<u>A</u> dapter
Underlined letter in a menu item	Indicates a shortcut you can use to expand a menu by pressing <Alt><menu underlined letter>. Pressing <Alt> again closes the menu. Menu shortcuts are allowed but cannot be used when a menu is active.	<u>V</u> irtual Disk 1
< >	Key presses are enclosed in angle brackets.	<F1>, <Esc>, <Enter>
<Enter>	After you highlight a menu item, press <Enter> to select that item. This opens an options menu for the menu item. This applies to only certain menu items, such as <b>Virtual Disk #</b> . In a list of options for that item, such as the write policy for a virtual disk, highlight a setting, such as <b>Write-Through</b> , and press <Enter> to select it.  In the right panel, you can press <Enter> to select <b>Tree View</b> or <b>List View</b> under the <b>View Type</b> heading.	Select <b>Add New VD</b> and press <Enter> to create a new virtual disk.
<Esc>	After you expand a pop-up window, press <Esc> to close the window. You can continue to press <Esc> to exit the BIOS Configuration Utility.	Press <Esc> to return to the <b>VD Mgmt</b> screen.

**Table 6-1. Menu Navigation Keys (continued)**

<b>Notation</b>	<b>Meaning and Use</b>	<b>Example</b>
<Tab>	Press <Tab> to move the cursor to the next control on a Dialog or page.	Press <Tab> to move the cursor to the next parameter you want to change.
<Shift> <Tab>	Press <Shift><Tab> to move the cursor to the previous control on a dialog or page.	Press <Shift><Tab> to move the cursor from <b>Virtual Disk</b> to <b>Disk Group #</b> .
<Ctrl> <N>	Press <Ctrl><N> to move to the next menu screen among the main menu screens: <b>VD Mgmt</b> , <b>PD Mgmt</b> , <b>Ctrl Mgmt</b> , and <b>Foreign View</b> .  When you return to the original menu, the cursor is on the same menu item it was on before you pressed <Ctrl><N>.	Press <Ctrl><N> on the <b>VD Mgmt</b> screen to move to the <b>PD Mgmt</b> screen.
<Ctrl> <P>	Press <Ctrl><P> to move to the previous menu screen among the main menu screens: <b>VD Mgmt</b> , <b>PD Mgmt</b> , <b>Ctrl Mgmt</b> , and <b>Foreign View</b> .  When you return to the previous screen, the cursor is on the same menu item it was on before you pressed <Ctrl><P>.	Press <Ctrl><P> on the <b>PD Mgmt</b> screen to return to the <b>VD Mgmt</b> screen.
<F1>	Press <F1> to access <b>Help</b> information. The <b>Help</b> screens display a glossary of topics you can use to access information about navigation, RAID levels, and general topics.	<F1>
<F2>	Press <F2> to access the context menu, which displays the list of options.	<F2>
<F5>	Press <F5> to refresh the information on the screen.	<F5>

**Table 6-1. Menu Navigation Keys (continued)**

<b>Notation</b>	<b>Meaning and Use</b>	<b>Example</b>
<F11>	Switch between two controllers.	<F11>
<F12>	Press <F12> to display a list of controllers.	<F12>
Spacebar	Press the spacebar to select an item, such as a virtual disk in the <b>List View</b> , select all the virtual disks ( <b>Mark All</b> ), or deselect all the virtual disks ( <b>Unmark All</b> ).	Press the spacebar to select each virtual disk on which you want to check data consistency.

## Setting Up Virtual Disks

This section contains the procedures used to set up a disk group and create virtual disks. Each of the following procedures are explained individually in this section in detail.

- 1 Create the virtual disks and select the virtual disk options.
- 2 Designate hot spares (optional).

For more information, see "Managing Dedicated Hot Spares" on page 94.



**NOTE:** A disk group is deleted when the last virtual disk in the disk group is deleted.

- 3 Initialize the virtual disks.



**NOTE:** When you use one physical disk group to create multiple virtual disks, all the virtual disks must be configured with the same RAID level.

When you define the virtual disks, you can set the virtual disk parameters described in Table 6-2.

- RAID level
- Stripe element size
- Read policy
- Write policy
- Type of initialization
- Hot spare configuration

**Table 6-2. Virtual Disk Parameters and Descriptions**

<b>Parameter</b>	<b>Description</b>
RAID Level	<p><b>RAID Level</b> specifies the whether the virtual disk is RAID 0, 1, 5, 6, 10, 50, and 60. The RAID level you select depends on the number of disks, disk capacity, and the requirements for fault tolerance and performance. See "Summary of RAID Levels" on page 17 for more information.</p>
Stripe Element Size	<p><b>Stripe Element Size</b> specifies the size of the segments written to each physical disk in a RAID 0, 1, 5, 6, 10, and 50 virtual disk. You can set the stripe element size to <b>8 KB, 16 KB, 32 KB, 64 KB, 128 KB, 256 KB, 512 KB, or 1024 KB</b>. The default and recommended stripe element size is <b>64 KB</b>.</p> <p>A larger stripe element size provides better read performance if your system does mostly sequential reads.</p>
Write Policy	<p><b>Write Policy</b> specifies the controller write policy. You can set the write policy to <b>Write-Back</b> or <b>Write-Through</b>.</p> <p>In <b>Write-Back</b> caching, the controller sends a data transfer completion signal to the host when the controller cache has received all the data in a transaction.</p> <p><b>NOTE:</b> If a BBU is present, the default cache setting is <b>Write-Back</b> cache. If no BBU is present, the default cache policy default setting is <b>Write-Through</b>.</p> <p><b>NOTICE:</b> If <b>Write-Back</b> is enabled and the system is quickly turned off and then on, the controller may pause as the system flushes cache memory. Controllers that contain a battery backup default to <b>Write-Back</b> caching.</p> <p>In <b>Write-Through</b> caching, the controller sends a data transfer completion signal to the host when the disk subsystem has received all the data in a transaction.</p> <p><b>Write-Back</b> caching has a performance advantage over <b>Write-Through</b> caching.</p> <p><b>NOTE:</b> Certain data patterns and configurations perform better with <b>Write-Through</b> cache policy.</p>

**Table 6-2. Virtual Disk Parameters and Descriptions (continued)**

<b>Parameter</b>	<b>Description</b>
Read Policy	<p><b>Read-ahead</b> enables the <b>Read-Ahead</b> feature for the virtual disk. You can set this parameter to <b>Read-ahead</b>, <b>No-read-ahead</b>, or <b>Adaptive</b>. The default is <b>No-read-ahead</b>.</p> <p><b>Read-ahead</b> specifies that the controller uses <b>Read-Ahead</b> for the current virtual disk. <b>Read-ahead</b> capability allows the controller to read sequentially ahead of requested data and store the additional data in cache memory, anticipating that the data is required soon.</p> <p><b>No-read-ahead</b> specifies that the controller does not use <b>Read-Ahead</b> for the current virtual disk.</p> <p><b>NOTE:</b> <b>No-Read-Ahead</b> shows higher performance results due to the effectiveness of hard-drive caching algorithms.</p> <p><b>Adaptive</b> specifies that the controller begins using <b>Read-Ahead</b> if the two most recent disk accesses occurred in sequential sectors. If all read requests are random, the algorithm reverts to <b>No-read-ahead</b>; however, all requests are still evaluated for possible sequential operation.</p>

## Virtual Disk Management

### Creating Virtual Disks

 **NOTE:** PERC 6 does not support creation of a virtual disk that combines SAS physical disks and SATA physical disks.

Perform the following steps to create virtual disks.

- 1 During host system bootup, press <Ctrl><R> when the BIOS banner displays.

The **Virtual Disk Management** screen displays. If there is more than one controller, the main menu screen displays. Select a controller, and press <Enter>. The **Virtual Disk Management** screen displays for the selected controller.

 **NOTE:** This procedure describes the BIOS Configuration Utility screens in Tree View.

- 2 Use the arrow keys to highlight **Controller #** or **Disk Group #**.

**3** Press <F2> to display the actions you can perform.

**4** Select **Create New VD** and press <Enter>.

The **Create New VD** screen displays. The cursor is on the **RAID Levels** option.

**5** Press <Enter> to display the possible RAID levels, based on the physical disks available.

**6** Press the down arrow key to select a RAID level and press <Enter>.

**7** Press <Tab> to move the cursor to the list of physical disks.

**8** Use the arrow key to highlight a physical disk and press the spacebar, <Alt>, or <Enter> to select the disk.

**9** Select additional disks, if desired.

**10** Press <Tab> to move the cursor to the box **Basic Settings**.

**11** Set the virtual disk size in the **VD Size** field.

The virtual disk size displays in megabyte (MB) format.



**NOTE:** For RAID levels 0, 1, 5, and 6 only, you can use part of the available disk space to create one virtual disk and then use the rest of the disk space to create another virtual disk or disks.



**NOTE:** The minimum virtual disk size is 100 MB.



**12** Press <Tab> to access the **VD Size** field, and type a virtual disk name.

**13** Press <Tab> to move the cursor to **Advanced Settings**.

**14** Press the spacebar to make the settings active so that you can change them.

An X displays beside **Advanced Settings**. The settings are the stripe element size, read policy, and write policy. You can also choose advanced options such as forcing the cache policy to be **Write-Back**, initializing the virtual disk, and configuring a dedicated hot spare.

The defaults for these parameters display when the window displays. You can accept the defaults or change them. For detailed information about the virtual disk parameters, see "Virtual Disk Parameters and Descriptions" on page 84.

- 15** Perform the following steps to select the virtual disk parameters:
- a** Press <Tab> to move the cursor to the parameters you want to change.
  - b** Press the down arrow key to open the parameters and scroll down the list of settings.
  - c** To change the stripe element size, press <Tab> to highlight **Stripe Element Size**.
  - d** Press <Enter> to display the list of stripe element sizes (8 KB, 16 KB, 32 KB, 64 KB, 128 KB, 256 KB, 512 KB, and 1024 KB), then press the down arrow key to highlight an option and press <Enter>. The default is 64 KB.
  - e** Press <Tab> to move the cursor to the **Read Policy** to change it if desired.
  - f** Press <Enter> to display the options, **No Read Ahead**, **Read Ahead**, or **Adaptive Read Ahead**, then press the down arrow key to highlight an option and press <Enter>.
  - g** Press <Tab> to move the cursor to the **Write Policy** to change it if desired.
  - h** Press <Enter> to display the options, **Write Through** or **Write Back**, and then press the down arrow key to highlight an option and press <Enter>.
  - i** Press <Tab> to move the cursor to **Force WB with no battery** and press <Enter>. If you chose **Write Through** as the write policy, then this option is not available.
  - j** Press <Tab> to move the cursor to **Initialize** and press <Enter>.
-  **NOTICE:** Do not initialize virtual disks when attempting to recreate an existing configuration.
-  **NOTE:** The initialization performed at this stage is fast initialization.
- k** Press <Tab> to move the cursor to **Configure HotSpare** and press <Enter>.
-  **NOTE:** The hot spare created at this stage is a dedicated hot spare.

- l** If you have chosen to create hot spares in the earlier steps a pop-up window appears where drives with appropriate sizes are displayed. Press the spacebar to select the drive size.  
Select the check box to enable the enclosure affinity setting for the hot spare.
- m** After you select the drive size, click **OK** to finalize the selection or click **Cancel** to forfeit the selection.
- n** Select **OK** to accept the settings and press <Enter> to exit this window or select **Cancel** and press <Enter> to exit if you do not want to change any virtual disk parameters.

## Initializing Virtual Disks



**NOTICE:** A full initialization permanently destroys any data that already exists.

Perform the following steps to initialize virtual disks.

- 1** On the **VD Mgmt** screen, select **Virtual Disk #** and press <F2> to display the menu of available actions.
- 2** Select **Initialization** and press the right arrow key to display the **Initialization** submenu options.
- 3** Select **Start Init.** to begin a regular initialization or select **Fast Init.** to begin a fast initialization.
- 4** A pop-up windows appears indicating that the virtual disk has been initialized.
- 5** Repeat the procedures in this section to configure another virtual disk.  
The PERC 6 controllers support up to 64 virtual disks per controller.  
The currently configured virtual disks display on the screen.

## Checking Data Consistency

Select the **Consistency Check (CC)** option in the configuration utility to verify the redundancy data in virtual disks that use RAID levels 1, 5, 6, 10, 50, and 60. (RAID 0 does not provide data redundancy.)



If you attempt to run a **Consistency Check** on a virtual disk that has not been initialized, the following error message displays:

The virtual disk has not been initialized. Running a consistency check may result in inconsistent messages in the log. Are you sure you want to continue?

You can select **Yes** or **No**. If you select **Yes**, the CC operation continues. If you select **No**, the operation ends.

Perform the following steps to run a **Consistency Check**.

- 1 Press <Ctrl><N> to access the **VD Mgmt** menu screen.
- 2 Press the down arrow key to highlight **Virtual Disk #**.
- 3 Press <F2> to display the menu of available actions.
- 4 Press the down arrow key to select **Consistency Check**.
- 5 Press the right arrow key to display the menu of available actions, **Start** and **Stop**.
- 6 Select **Start** and press <Enter> to run a **Consistency Check**.  
The **Consistency Check** runs and checks the redundancy data in the virtual disks.
- 7 After you start the **Consistency Check**, press <Esc> to display the previous menu.

## **Importing or Clearing Foreign Configurations Using the VD Mgmt Menu**

When a foreign configuration exists, the BIOS banner displays the message **Foreign configuration(s) found on adapter**. In addition, a foreign configuration, when present, appears on the right side of the **VD Mgmt** screen.

You can use the **VD Mgmt** menu to import the existing configuration to the RAID controller or clear the existing configuration to create a new one. In addition, you can view the foreign drive data from the **Foreign View** tab without importing the configuration.



**NOTE:** The controller does not allow an import that results in more than 64 virtual disks.

Perform the following steps to import or clear foreign configurations.

- 1 During bootup, press <Ctrl><R> when prompted by the BIOS banner. The **VD Mgmt** screen appears by default.
- 2 On the **VD Mgmt** screen, highlight the **Controller #**.  
The controller number is the only item that appears until you import the foreign configuration.
- 3 Press <F2> to display the available actions.
- 4 Press the right arrow key to display the available actions, **Import** and **Clear**.



**NOTE:** Ensure that your virtual disk has all the physical disks by verifying that there are no physical disks marked as **Missing** in the foreign view page and that all the disks appear as expected before importing them.

- 5 Select **Import** to import the foreign configuration or **Clear** to delete the foreign configuration and then press <Enter>.

If you import the configuration, the **VD Mgmt** displays detailed configuration information. This includes information about the disk groups, virtual disks, physical disks, space allocation, and hot spares.

## Importing or Clearing Foreign Configurations Using the Foreign Configuration View Screen

If one or more physical disks are removed from a configuration, for example, by a cable pull or physical disk removal, the configuration on those disks is considered a foreign configuration by the RAID controller.

You can use the **Foreign Configuration View** screen to view information about the foreign configuration, such as disk groups, virtual disks, physical disks, space allocation, and hot spares. The foreign configuration data appears in the same format as configurations on the **VD Mgmt** screen. You can use this screen to view the foreign configuration before you decide whether to import it. After you view the foreign configuration, you can either import it to the RAID controller or clear it.



**NOTE:** Before you import, review the configuration on the screen to ensure that it is the desired end result.

You can use the **Foreign Configuration View** screen to manage foreign configurations in the following cases:

- All the physical disks in a configuration are removed and re-inserted.
- Some of the physical disks in a configuration are removed and re-inserted.
- All the physical disks in a virtual disk are removed, but at different times, and then re-inserted.
- The physical disks in a non-redundant virtual disk are removed.

The following constraints apply to the physical disks that are considered for import:

- The drive state of a physical disk can change from the time the foreign configuration is scanned to when the actual import occurs. The foreign import occurs only on drives that are in the **Unconfigured Good** state.
- Drives in the failed or offline state cannot be imported.
- The firmware does not allow you to import more than eight foreign configurations.

Perform the following procedures on the **Foreign Configuration View** screen to manage foreign configurations in each specific case:

- 1 If all or some of the physical disks in a configuration are removed and re-inserted, the controller considers the drives to have foreign configurations. Perform the following steps:

- a Select **Foreign Configuration View** to display the foreign configuration information on the **Foreign Configuration View** screen.
- b Press <F2> to display the options **Import** or **Clear**.



**NOTE:** You must have all the drives in the system before you perform the import operation.

- c Select **Import** to import the foreign configuration to the controller or select **Clear** to delete the foreign configuration(s) from the re-inserted disk(s).

In the **Preview Configuration Data** window, the status of a physical disk that needs to be rebuilt is displayed as **Rebuild**.

 **NOTE:** When you import a foreign configuration, the dedicated hot spares in the configuration are imported as dedicated hot spares on two conditions - the associated virtual disk is already present or the associated virtual disk is also imported along with the configuration.

 **NOTE:** Start a consistency check immediately after the rebuild is complete to ensure data integrity for the virtual disks. For more information about checking data consistency, see "Checking Data Consistency" on page 88.

- 2 If all the physical disks in a virtual disk are removed, but at different times, and re-inserted, the controller considers the disks to have foreign configurations. Perform the following steps:
  - a Select **Foreign Configuration View** to display the complete virtual disk, across different foreign configurations and allow foreign configurations to be imported.

- b Press <F2> to display the options **Import** or **Clear**.

 **NOTE:** You must have all the drives in the system before you perform the import operation.

- c Select **Import** to merge the foreign configurations with the existing configuration on the controller or **Clear** to delete the foreign configuration(s) from the re-inserted disk(s).

If you select **Import**, all drives that were pulled before the virtual disk became offline are imported, and then automatically rebuilt.

 **NOTE:** Start a consistency check immediately after the rebuild is complete to ensure data integrity for the virtual disks. For more information about checking data consistency, see "Checking Data Consistency" on page 88.

- 3 If the physical disks in a non-redundant virtual disk are removed, the controller considers the drives to have foreign configurations. Perform the following steps:

- a Select **Foreign Configuration View** to display the complete foreign configuration information.
  - b Press <F2> to display the options **Import** or **Clear**.
  - c Select **Import** to import the foreign configuration to the virtual disk or **Clear** to delete the foreign configuration(s) from the re-inserted disk(s).

No rebuilds occur after the import operation because there is no redundant data to rebuild the drives with.

## Managing Preserved Cache

If a virtual disk becomes offline or is deleted because of missing physical disks, the controller preserves the dirty cache from the virtual disk. This preserved dirty cache, known as pinned cache, is preserved until you import the virtual disk or discard the cache.



**NOTE:** Certain operations, such as creating a new virtual disk, cannot be performed if pinned cache exists. You have to enter the BIOS Configuration Utility to resolve the situation before you boot to the operating system. Messages are displayed notifying you that you must enter the BIOS Configuration Utility to discard the pinned cache or import the virtual disks with the pinned cache.



**CAUTION:** If there are any foreign configurations, it is strongly advised that you import the foreign configuration before you discard the preserved cache. Otherwise, you might lose data that belongs with the foreign configuration.

Perform the following steps to select whether to import the virtual disk or discard the preserved cache.

- 1 On the **VD Mgmt** screen, click on a controller icon.
- 2 Press <F2> to display the menu of available actions.
- 3 Select **Manage Preserved Cache**.

A message displays to advise you to import the foreign configuration before you discard the preserved cache. Otherwise, you can lose data that belongs with the foreign configuration. Confirm whether you want to continue. The **Manage Preserved Cache** screen displays the affected virtual disks.

- 4 On the **Manage Preserved Cache** screen, choose whether to discard the cache. You can discard the cache or press **Cancel** to display the **Preserved Cache Retained** dialog box.

If you choose to discard the cache, you are prompted to confirm your choice. If you choose to retain the cache, a message displays to notify you that you cannot perform certain operations while the cache exists. Click **OK** to continue.

Some operations, such as creating a new virtual disk, are not allowed if preserved cache exists. A message warns you that you cannot perform the operation while preserved cache exists. If you choose to clear a configuration, and preserved cache exists, a message warns you that all data on all virtual drives is lost and the preserved cache is discarded.

## Managing Dedicated Hot Spares

A dedicated hot spare automatically replaces a failed physical disk only in the selected disk group which the hot spare is part of. A dedicated hot spare is used before a global hot spare is used. You can create dedicated hot spares or delete them on the **VD Mgmt** screen. Perform the following steps to create or delete dedicated hot spares.

- 1 On the **VD Mgmt** screen, select **Disk Group #** and press <F2> to display the menu of available actions.

The available menu options appear.

- 2 Select **Manage Ded. HS** and press <Enter>.

A screen displays a list of the current dedicated hot spares and the physical disks that are available to create dedicated hot spares. An X displays next to the current dedicated hot spares.

 **NOTE:** The utility allows only disks of the same drive technology and of equal or greater size to be selected as dedicated hot spare.

- 3 To create a dedicated hot spare, press the down arrow key to highlight an available physical disk and press the spacebar to select the disk. Repeat this procedure for each dedicated hot spare that you want to create.

An X displays beside the selected physical disk(s).

- 4 To delete a dedicated hot spare, use the down arrow key to highlight a current hot spare and press the spacebar to deselect the disk. Repeat this procedure for each dedicated hot spare that you want to delete.

- 5 Press <Enter> to approve the changes.

The **VD Mgmt** screen displays the updated list of hot spares under the **Hot spares** heading.

 **NOTE:** If a global hot spare or dedicated hot spare is removed and re-inserted, it regains its status as a hot spare.

 **NOTE:** If a dedicated hot spare is removed, re-inserted, and then imported, the physical disk changes to a global hot spare upon completion of the foreign configuration import.

## Deleting Virtual Disks

To delete virtual disks, perform the following steps in the BIOS Configuration Utility.



**NOTE:** You cannot delete a virtual disk during an initialization.



**NOTE:** Warning messages are displayed stating the effect of deleting a virtual disk. Click **OK** twice to complete the virtual disk deletion.

- 1 Press <Ctrl><N> to access the **VD Mgmt** screen.
- 2 Press <Tab> to move the cursor to a virtual disk under the **Virtual Disks** heading.
- 3 Press <F2>.  
The action menu appears.
- 4 Select **Delete VD** and press <Enter>.
- 5 On the **VD Mgmt** screen, select **Space Allocation** to display the amount of free space available after you delete the virtual disk.

## Deleting Disk Groups

You can delete disk groups using the BIOS Configuration Utility. When you delete a disk group, the utility also removes the virtual disks in that disk group.

To delete disk groups, perform the following steps in the BIOS Configuration Utility.

- 1 Press <Ctrl><N> to access the **VD Mgmt** screen.
- 2 Press <Tab> to move the cursor to a disk group under the **Virtual Disks** heading.
- 3 Press <F2>.  
The action menu displays.
- 4 Select **Delete Disk Group** and press <Enter>.

This deletes the disk group. When you delete a disk group, the remaining disk groups with higher numbers are automatically renumbered. For example, if you delete disk group #2, disk group #3 is then automatically renumbered as disk group #2.

## Resetting the Configuration

You can delete all virtual disks on the RAID controller by performing this operation.

To reset the configuration, perform the following steps in the BIOS Configuration Utility:

- 1 Press <Ctrl><N> to access the **VD Mgmt** screen.
- 2 Press <Tab> or use the arrow keys to move the cursor to the **Controller** heading.
- 3 Press <F2>. The action menu appears.
- 4 Select **Reset Configuration**.  
A pop-up window appears prompting for confirmation to delete all virtual disks.
- 5 Select **OK** to delete the virtual disks or **Cancel** to retain the existing configuration.

## BIOS Configuration Utility Menu Options

The first menu that displays when you access the BIOS Configuration Utility is the main menu screen. It lists the controller, controller number, and other information, such as the slot number. On this screen, you can select use the arrow keys to select the RAID controller you want to configure. Press <Enter> to access the controller.

This section describes the options for the BIOS Configuration Utility for each of the major menus:

- **Virtual Disk Management (VD Mgmt)** menu
- **Physical Disk Management (PD Mgmt)** menu
- **Controller Management (Ctrl Mgmt)** menu
- **Foreign Configuration View** menu

Most menus consist of two panels:

- A left panel with the menu options
- A right panel with details of the items selected in the left panel

The following sections describe the menu and submenu options for each of the major menus.



## Virtual Disk Management (VD Mgmt)

The **Virtual Disk Management** screen, **VD Mgmt**, is the first screen that displays when you access a RAID controller from the main menu screen on the BIOS Configuration Utility. In the **Tree View**, the left panel displays the menus for the virtual disk management, which are:

- **Controller #**
  - **Disk Group #**
    - **Virtual Disks** (displayed in descending numerical order)
    - **Physical Disks** (individual physical disks are displayed in enclosure:slot format)
    - **Space Allocation** (virtual disk size and free space you can use to create a virtual disk)
    - **Hot Spares** (global and dedicated)

In the **Tree View**, the right panel displays detailed information for the selected controllers, disk groups, virtual disks, physical disks, space allocation, and hot spares, as shown in Table 6-3.

**Table 6-3. Information on the Virtual Disk Management Screen**

<b>Menu Item Selected in Left Panel</b>	<b>Information That Displays in Right Panel</b>
Controller #	Controller Properties: <ul style="list-style-type: none"><li>• Number of disk groups (DG)</li><li>• Number of virtuals disks (VD)</li><li>• Number of physical disks (PD)</li></ul>
Disk Group #	Disk Group # Properties: <ul style="list-style-type: none"><li>• Number of virtuals disks (VD)</li><li>• Number of physical disks (PD)</li><li>• Space available on the physical disks</li><li>• Number of free segments</li><li>• Number of dedicated hot spares</li></ul>

**Table 6-3. Information on the Virtual Disk Management Screen (continued)**

<b>Menu Item Selected in Left Panel</b>	<b>Information That Displays in Right Panel</b>
Virtual Disks	Disk Group # Properties: <ul style="list-style-type: none"><li>• Number of virtuals disks (VD)</li><li>• Number of physical disks (PD)</li><li>• Space available in the virtual disk</li><li>• Number of free segments</li><li>• Number of dedicated hot spares</li></ul>
Virtual Disk #	Virtual Disk # Properties: <ul style="list-style-type: none"><li>• RAID level (0, 1, 5, 6, 10, 50, or 60)</li><li>• RAID status of the virtual disk (Failed, Degraded, or Optimal)</li><li>• Size of the virtual disk</li><li>• Operation currently in progress</li></ul> Disk Group # Properties: <ul style="list-style-type: none"><li>• Number of virtuals disks (VD)</li><li>• Number of physical disks (PD)</li><li>• Space available on the physical disks</li><li>• Number of free segments</li><li>• Number of dedicated hot spares</li></ul>
Physical Disks	Disk Group # Properties: <ul style="list-style-type: none"><li>• Number of virtuals disks (VD)</li><li>• Number of physical disks (PD)</li><li>• Space available on the physical disks</li><li>• Number of free segments</li><li>• Number of dedicated hot spares</li></ul>

**Table 6-3. Information on the Virtual Disk Management Screen (continued)**

<b>Menu Item Selected in Left Panel</b>	<b>Information That Displays in Right Panel</b>
Physical Disk #	Physical Disk Properties: <ul style="list-style-type: none"><li>• Vendor name</li><li>• Physical disk size</li><li>• Physical disk state</li></ul> Disk Group # Properties: <ul style="list-style-type: none"><li>• Number of virtuals disks (VD)</li><li>• Number of physical disks (PD)</li><li>• Space available on the physical disks</li><li>• Number of free segments</li><li>• Number of dedicated hot spares</li></ul>
Space Allocation	Disk Group # Properties: <ul style="list-style-type: none"><li>• Number of virtuals disks (VD)</li><li>• Number of physical disks (PD)</li><li>• Space available on the physical disks</li><li>• Number of free segments</li><li>• Number of dedicated hot spares</li></ul>
Hot Spares	Physical disk properties: <ul style="list-style-type: none"><li>• Vendor name</li><li>• Physical disk size</li><li>• Physical disk state</li></ul> Disk group # properties: <ul style="list-style-type: none"><li>• Number of virtuals disks (VD)</li><li>• Number of physical disks (PD)</li><li>• Space available on the physical disks</li><li>• Number of free segments</li><li>• Number of dedicated hot spares</li></ul>



**NOTE:** The List View of the Virtual Disk Management screen displays different options from the Tree View.

## Virtual Disk Actions

Table 6-4 describes the actions you can perform on virtual disks. For procedures you can use to perform these actions, See "Physical Disk Management" on page 104.

**Table 6-4. Virtual Disk Actions**

Action	Description
Create a new virtual disk	Creates a new virtual disk from one or more physical disks. You can configure hot spares when you create a virtual disk.
Manage dedicated hot spares	Creates or deletes a hot spare that can be dedicated to a single redundant virtual disks.
Initialize a virtual disk	Initializes the selected virtual disk. Every virtual disk that is configured must be initialized. You can perform a fast initialization or a full initialization.
Check data consistency on a virtual disk	Verifies the correctness of the redundancy data in the selected virtual disk. This option is available only if RAID level 1, 5, 6, 10, 50, or 60 is used. The PERC 6 controllers automatically correct any differences found in the data.
Display or update virtual disk parameters	Displays the properties of the selected virtual disk. You can modify the cache write policy, read policy, and the input/output (I/O) policy from this menu.
Manage preserved cache	Preserves the dirty cache from a virtual disk if it becomes offline or is deleted. The dirty cache is preserved until you import the virtual disk or discard the cache.
Delete a virtual disk	Deletes the virtual disk and frees up disk space to create another virtual disk.
Delete a disk group	Deletes a disk group, which is a collection of disks from one or more disk subsystems controlled by management software.

## Physical Disk Management (PD Mgmt)

The **Physical Disk Management** screen, **PD Mgmt**, displays physical disk information and action menus. The screen displays physical disk IDs, vendor names, disk size, type, state, and disk group (**DG**). You can sort the list of physical disks based on these headings. You can perform several actions on the physical disks, including the following:

- Rebuilding physical disks
- Performing the Replace Member operation
- Setting the LED to blink
- Making a disk online or offline (unaffiliated with a disk group)
- Creating global hot spares
- Removing dedicated hot spares or global hot spares

### *Physical Disk Actions*

Table 6-5 describes the actions you can perform on physical disks. For procedures that can be used to perform these actions, see "Physical Disk Management" on page 104.

**Table 6-5. Physical Disk Actions**

<b>Action</b>	<b>Description</b>
Rebuild	Regenerates all data to a replacement disk in a redundant virtual disk (RAID level 1, 5, 6, 10, 50, or 60) after a disk failure. A disk rebuild normally occurs without interrupting normal operations on the affected virtual disk.
Replace Member	Replaces the drive in the virtual disk with another drive that can be selected.
LED Blinking	Indicates when physical disks are being used to create a virtual disk. You can choose to start or stop the LED blinking.
Force Online	Changes the state of the selected physical disk to online.
Force Offline	Changes the state of the selected physical disk so that it is no longer part of a virtual disk.

**Table 6-5. Physical Disk Actions (continued)**

<b>Action</b>	<b>Description</b>
Make Global HS	Designates the selected physical disk as a global hot spare. A global hot spare is part of a pool for all virtual disks controlled by the controller.  Designates the selected physical disk as a global hot spare. You can select the hot spare to have enclosure affinity.
Remove HS	Removes a dedicated hot spare from its disk group or a global hot spare from the global pool of hot spares.

### ***Rebuild***

Select **Rebuild** to rebuild one or more failed physical disks. For information on performing a physical disk rebuild, see "Performing a Manual Rebuild of an Individual Physical Disk" on page 107.

If no workload is placed on the storage subsystem, the controller rebuilds SAS drives at a rate of approximately 200 GB/hour and SATA drives at a rate of approximately 100 GB/hour. Several of the controller configuration settings and the virtual disk settings affect the actual rate of rebuild. These factors include the rebuild rate setting, virtual disk stripe size, virtual disk Read Policy, virtual disk Write Policy, and the amount of workload placed on the storage subsystem. For information on getting the best rebuild performance from your RAID controller, see the documentation on Dell Support website at [support.dell.com](http://support.dell.com).

### **Controller Management (Ctrl Mgmt)**

The **Controller Management** screen, **Ctrl Mgmt**, displays the product name, package, BIOS version, firmware version, BIOS Configuration Utility version, and boot block. Use this screen to perform actions on the controller and BIOS. You can use this screen to enable or disable the controller BIOS and the BIOS during bootup in event of BIOS errors. In addition, you can select a virtual disk from which to boot, select default settings, and reset the configuration.

## Controller Management Actions

Table 6-6 describes the actions you can perform on the **Ctrl Mgmt** screen.

**Table 6-6. Controller Management Options**

Option	Description
Enable Controller BIOS	Select this option to enable the controller BIOS. If the boot device is on the RAID controller, the BIOS must be enabled. Disable the BIOS to use other boot devices.  In a multiple controller environment, you can enable BIOS on multiple controllers. However, if you want to boot from a specific controller, then enable the BIOS on that controller and disable it on the other controllers. The system can then boot from the BIOS-enabled controller.
Enable Alarm	Select this option to enable or disable the audible alarm on the controller, if alarm hardware is present. The alarm sounds to warn you of any problems with the physical disks or the virtual disks.
Enable BIOS Stop On Error	Select this option to stop the system BIOS during bootup if there are BIOS errors. This option enables you to enter the configuration utility to resolve the problem.
Select Bootable VD	Select this option to specify a virtual disk as the boot disk on the controller. This option displays if you have built virtual disks.
Factory Default	Select this option to restore the default settings for the options in the <b>Settings</b> box.

## Foreign Configuration View

When a foreign configuration is present, you can select **Foreign Configuration View** to display the configuration. This screen shows the foreign configuration as it would be if you import it. You can preview the foreign configuration before you decide whether to import it or clear it.

In some cases, a foreign configuration cannot be imported. If a physical disk in a virtual disk is rebuilding, the physical disk's state is set to **Rebuild**. For the virtual disks, the text **Importable** or **Not Importable** displays next to each virtual disk. No virtual disk target ID displays for virtual disks that cannot be imported.

The section "Importing or Clearing Foreign Configurations Using the Foreign Configuration View Screen" on page 90 contains the procedures you can use to manage the foreign configurations.



**NOTE:** The BIOS Configuration Utility reports error codes for failed imports of foreign configurations.

## Physical Disk Management

### Setting LED Blinking

The LED blinking option indicates when physical disks are being used to create a virtual disk. You can choose to start or stop the LED blinking. Perform the following steps to start or stop this option.

- 1 Press <Ctrl><N> to access the **PD Mgmt** screen.  
A list of physical disks appears. The status of the each disk displays under the heading **State**.
- 2 Press the down arrow key to highlight a physical disk.
- 3 Press <F2> to display the menu of available actions.
- 4 Press the down arrow key to highlight **LED Blinking**.
- 5 Press the right arrow key to display the available actions, **Start** and **Stop**.
- 6 Select **Start** to begin LED blinking or **Stop** to end LED blinking.

### Creating Global Hot Spares

A global hot spare can be used to replace a failed physical disk in any redundant array as long as the capacity of the global hot spare is equal to or larger than the coerced capacity of the failed physical disk.

You can designate the hot spare to have enclosure affinity, meaning that if there are drive failures present on a split backplane configuration, then the hot spare is first used on the backplane that it resides in.



Perform the following steps to create global hot spares.

- 1 Press <Ctrl><N> to access the **PD Mgmt** screen.

A list of physical disks displays. The status of the each disk displays under the heading **State**.

- 2 Press the down arrow key to highlight a physical disk to change to a global hot spare.
- 3 Press <F2> to display the menu of available actions.
- 4 Press the down arrow key to highlight **Make Global HS** and press <Enter>.

The physical disk is changed to a global hot spare. The status of the physical disk as a global hot spare displays under the heading **State**.



**NOTE:** To replace a failed physical disk global hot spares must use the same drive technology and must be equal or greater in size.

- 5 Select additional physical disks if desired and follow the previous steps to change them to global hot spares.

## Removing Global or Dedicated Hot Spares

You can remove one global or dedicated hot spare at a time on the **PD Mgmt** screen. Perform the following steps to remove a global hot spare or dedicated hot spare.

- 1 Press <Ctrl><N> to access the **PD Mgmt** screen.

A list of physical disks displays. The status of each disk displays under the heading **State**.

- 2 Press the down arrow key to highlight a physical disk that is a hot spare.
- 3 Press <F2> to display the menu of available actions.

- 4 Press the down arrow key to select **Remove Hot Spare** from the list of actions and press <Enter>.

The physical disk is changed to the **Ready** state. The status of the physical disk is displayed under the heading **State**.



**NOTE:** Try to use physical disks of the same capacity in a specific virtual disk. If you use physical disks with different capacities in a virtual disk, all physical disks in the virtual disk are treated as if they have the capacity of the smallest physical disk.

- 5 Select additional hot spares if desired and follow step 1 to step 4 to remove them.

## Replacing an Online Physical Disk

In addition to the automatic **Replace Member** operation, you can manually replace any physical disk that is part of a virtual disk using the **Replace Member** functionality. Perform the following steps to replace a physical disk:

- 1 In the **Virtual Disk Management** window, select **Virtual Disk #** and press the down arrow key until **Physical Disks** is highlighted.
- 2 Press the right arrow key to expand the list of physical disks that are members of the virtual disk.
- 3 Press the down arrow key until the desired physical disk you want to replace is highlighted. Press <F2> to expand the list of allowed operations on this disk.
- 4 Select **Replace** and then **Start**.
- 5 Press the down arrow to highlight a replacement disk and then press the spacebar to select the disk.
- 6 Select **OK** to start the replacement.



**NOTE:** The replacement disk must be a hot spare or an unconfigured disk without a foreign configuration. It must have the same or greater capacity and should be of the same type (SAS/SATA) as the disk it is replacing.

## Restrictions and Limitations

The following restrictions and limitations apply to the **Replace Member** operation:

- The **Replace Member** functions are restricted to one per array for RAID 0, RAID 1, and RAID 5, and two per array for RAID 6.
- The **Replace Member** function and rebuild cannot run simultaneously on a RAID 6 virtual disk. The rebuild operation has a higher priority, and the **Replace Member** operation is aborted if a rebuild begins.

## Stopping Background Initialization

Background initialization is the automated operation in which parity is created and written. BGI does not run on RAID 0 virtual disks. Under certain conditions, the BIOS Configuration Utility displays a message if you want to stop BGI in progress. An alert message displays if BGI is in progress and you start any of the following actions:

- A full initialization on the virtual disk
- A fast initialization on the virtual disk
- A consistency check on the virtual disk

The following alert message displays: `The virtual disk is undergoing a background initialization process. Would you like to stop the operation and proceed with the <full initialization/quick initialization/consistency check> instead?`

Click **Yes** to stop the BGI and start the requested operation or **No** to allow the BGI to continue.

## Performing a Manual Rebuild of an Individual Physical Disk

Use the following procedures to rebuild one failed physical disk manually.

- 1 Press <Ctrl><N> to access the **PD Mgmt** screen.  
A list of physical disks appears. The status of each disk appears under the heading **State**.
- 2 Press the down arrow key to highlight a physical disk that has a failed state.

- 3 Press <F2> to display a menu of available actions.  
The **Rebuild** option is highlighted at the top of the menu.
- 4 Press the right arrow key to display the rebuild options and select **Start**.
- 5 After you start the rebuild, press <Esc> to display the previous menu.



**NOTE:** You can also use the **VD Mgmt** screen to perform a manual rebuild. Use the arrow key to highlight physical disk in the tree view, and press <F2>. In the menu that displays, select the **Rebuild** option.



**NOTICE:** If a physical disk is a member of a disk group that contains multiple virtual disks and one of the virtual disks is deleted when a rebuild operation is in progress, the rebuild operation stops. If this occurs, you can resume the rebuild operation manually using a storage management application. To avoid interruption, ensure that none of the virtual disks are deleted until the rebuild is complete.

## Controller Management

### Enabling Boot Support



**NOTE:** Refer to your system documentation to ensure the proper boot order is selected in the system BIOS.

In a multiple controller environment, you can enable BIOS on multiple controllers. However, if you want to boot from a specific controller, then enable the BIOS on that controller and disable it on the other controllers. The system can then boot from the BIOS-enabled controller. Perform the following steps to enable the controller BIOS.

- 1 Press <Ctrl><N> to access the **Ctrl Mgmt** menu screen.
- 2 Press <Tab> to move the cursor to **Enable Controller BIOS** in the **Settings** box.
- 3 Press the spacebar to select **Enable Controller BIOS**.  
An **X** displays beside **Enable Controller BIOS**.
- 4 Press <Tab> to move the cursor to the **Apply** button, and then press <Enter> to apply the selection.

The controller BIOS is enabled. To disable the controller BIOS, use the spacebar to deselect the **Enable Controller BIOS** control, and then select **Apply** and press <Enter>.

After you enable the BIOS for a controller, perform the following steps to enable the boot support for that controller.

- 1 Press <Ctrl><N> to access the **Ctrl Mgmt** menu screen.
- 2 Press <Tab> to move the cursor to the **Select Bootable VD** in the **Settings** box.
- 3 Press the down arrow key to display a list of virtual disks.
- 4 Use the down arrow key to highlight a virtual disk.
- 5 Press <Enter> to select the virtual disk.
- 6 Press <Tab> to move the cursor to the **Apply** button, and then press <Enter> to apply the selection.

Boot support is enabled for the selected controller.

### **Enabling BIOS Stop on Error**

The option **BIOS Stop on Error** is used to stop the system from booting if there are BIOS errors. Perform the following steps to enable **BIOS Stop on Error**.

- 1 Press <Ctrl><N> to access the **Ctrl Mgmt** menu screen.
- 2 Press <Tab> to move the cursor to **Enable BIOS Stop on Error** in the **Settings** box.
- 3 Press the spacebar to select **Enable BIOS Stop on Error**.  
An **X** displays beside **Enable BIOS Stop on Error**.
- 4 Press <Tab> to move the cursor to the **Apply** button, and then press <Enter> to apply the selection.

The controller BIOS is enabled. To disable **Enable BIOS Stop on Error**, use the spacebar to deselect **Enable BIOS Stop on Error**, then select **Apply** and press <Enter>.

## Restoring Factory Default Settings

You can use the **Ctrl Mgmt** menu screen to restore the default settings for the options in the **Settings** box. The settings are **Enable Controller BIOS**, **Enable Alarm**, and **Enable BIOS Stop on Error**. Perform the following steps to restore default settings.

- 1 Press <Ctrl><N> to access the **Ctrl Mgmt** menu screen.
- 2 Press <Tab> to move the cursor to the **Settings** box.
- 3 Use the spacebar to deselect the settings for the options in the **Settings** box.
- 4 Press <Tab> to move the cursor to the **Factory Default** box, and press the <Alt>, <Enter>, or the spacebar.

A dialog box displays for you to confirm your choice.

- 5 Select <OK> and press <Enter>.

The defaults are automatically selected for the controller settings and are displayed in **Settings**.

# Troubleshooting

To get help with your Dell™ PowerEdge™ Expandable RAID Controller (PERC) 6 and Dell Cost-Effective RAID Controller (CERC) 6/i controller, you can contact your Dell Technical Service representative or access the Dell Support website at [support.dell.com](http://support.dell.com).

## Post Error Messages

The controller BIOS read-only memory, ROM provides INT 13h functionality (disk I/O) for the virtual disks connected to the controller, so that you can boot from or access the physical disks without the need of a driver. Table 7-1 describes the error messages and warning messages that display for the BIOS. Table 7-2 describes the error messages that display for displays the battery backup unit (BBU).

**Table 7-1. BIOS Errors and Warnings**

Message	Meaning
BIOS Disabled. No Logical Drives Handled by BIOS	<p>This warning message displays after you disable the <b>ROM</b> option in the configuration utility. When the <b>ROM</b> option is disabled, the BIOS cannot boot Int13h and cannot provide the ability to boot from the virtual disk.</p> <p>Int13h is an interrupt signal that supports numerous commands that are sent to the BIOS, then passed to the physical disk. The commands include actions you can perform with a physical disk, such as reading, writing, and formatting.</p>
Press <Ctrl><R> to Enable BIOS	<p>When the BIOS is disabled, you are given the option to enable it by entering the configuration utility. You can change the setting to <b>Enabled</b> in the configuration utility.</p>

**Table 7-1. BIOS Errors and Warnings (continued)**

<b>Message</b>	<b>Meaning</b>
Adapter at Baseport xxxx is not responding where xxxx is the baseport of the controller	If the controller does not respond for any reason but is detected by the BIOS, it displays this warning and continues.  Turn off the system and try to reset the controller. If this message is still displayed, contact Dell Technical Support.
There are offline or missing virtual drives with preserved cache.  Please check the cables and ensure that all drives are present. Press any key to enter the configuration utility.	If a virtual disk becomes offline or is deleted because of missing physical disks, the controller preserves the dirty cache from the virtual disk.  This preserved dirty cache is called pinned cache, and is preserved until you import the virtual disk, or discard the cache.  Use the Ctrl+R utility to select whether to import the VD or discard the pinned cache. For the steps used to manage preserved cache, see "Managing Preserved Cache" on page 93.
x Virtual Disk(s) Offline where x is the number of virtual disks failed	When the BIOS detects virtual disks in the offline state, it displays this warning. You should check to determine why the virtual disks failed and correct the problem. BIOS does not take any action.
x Virtual Disk(s) Degraded where x is the number of virtual disks degraded	When the BIOS detects virtual disks in a degraded state, it displays this warning. You should try to make the virtual disks optimal. BIOS does not take any action.
x Virtual Disk(s) Partially Degraded	When the BIOS detects a single disk failure in a RAID 6 or 60, it displays this warning. You must check why the member disk is not present to correct the problem. BIOS does not take any action.



**Table 7-1. BIOS Errors and Warnings (continued)**

Message	Meaning
Memory/Battery problems were detected. The adapter has recovered, but cached data was lost. Press any key to continue.	<p>This message occurs under the following conditions:</p> <ul style="list-style-type: none"><li>• The adapter detects that the cache in the controller cache has not yet been written to the disk subsystem.</li><li>• The controller detects an error-correcting code (ECC) error while performing its cache checking routine during initialization.</li><li>• The controller then discards the cache rather than sending it to the disk subsystem because the data integrity cannot be guaranteed.</li></ul> <p>To resolve this problem, allow the battery to charge fully. If the problem persists, the battery or adapter DIMM might be faulty. In that case, contact Dell Technical Support.</p>
Firmware is in Fault State	Contact Dell Technical Support.
Firmware version inconsistency was detected. The adapter has recovered, but cached data was lost. Press any key to continue.	<p>New firmware has been flashed that is incompatible with the previous version. The cache contains data that has not been written to the physical disks and that cannot be recovered. Check data integrity. You may need to restore the data from a backup.</p>
Foreign configuration(s) found on adapter. Press any key to continue, or 'C' to load the configuration utility or 'F' to import foreign configuration(s) and continue.	<p>When a controller firmware detects a physical disk with existing foreign metadata, it flags the physical disk as <i>foreign</i> and generates an alert indicating that a foreign disk was detected.</p> <p>Press &lt;F&gt; at this prompt to import the configuration (if all member drives of the virtual disk are present) without loading the BIOS configuration utility. Or, press &lt;C&gt; to enter the BIOS configuration utility and either import or clear the foreign configuration.</p>

**Table 7-1. BIOS Errors and Warnings (continued)**

Message	Meaning
The foreign configuration message is always present during POST but no foreign configurations are present in the foreign view page in CTRL+R and all virtual disks are in an optimal state.	Clear the foreign configuration using CTRL+R or Dell OpenManage™ Server Administrator Storage Management. <b>NOTE:</b> The physical disk goes to Ready state when you clear the foreign configuration and this may lead to data loss. If a physical disk is inserted into the system that was previously a member of a virtual disk, and that disk's previous location has been taken by a replacement disk through a rebuild, the newly inserted disk that was previously a member of the virtual disk must have its foreign configuration flag manually removed.
Previous configuration(s) cleared or missing. Importing configuration created on XX/XX XX.XX. Press any key to continue, or 'C' to load the configuration utility.	The message indicates that the controller and physical disks have different configurations. You can use the BIOS Configuration Utility to clear the foreign configuration.
Invalid SAS topology detected. Please check your cable configurations, repair the problem, and restart your system.	The SAS cables for your system are improperly connected. Check the cable connections and fix problems if any. Restart the system.

**Table 7-1. BIOS Errors and Warnings (continued)**

Message	Meaning
Multibit ECC errors were detected on the RAID controller. If you continue, data corruption can occur. Contact technical support to resolve this issue. Press 'X' to continue or else power off the system, replace the controller and reboot.	<p>This error is specific to PERC 6/i controller.</p> <p>Multi-bit ECC errors (MBE) occur in the memory and can corrupt cached data and discard it.</p> <p><b>NOTICE:</b> MBE errors are serious, as they cause data corruption and data loss. In case of MBE errors, contact Dell Technical Support.</p> <p><b>NOTE:</b> A similar message appears when multiple single-bit ECC errors are detected on the controller during bootup.</p>
Multibit ECC errors were detected on the RAID controller. The DIMM on the controller needs replacement. If you continue, data corruption can occur. Press 'X' to continue or else power off the system and replace the DIMM module and reboot. If you have replaced the DIMM please press 'X' continue.	<p>This error is specific to PERC 6/E controller.</p> <p>Multi-bit ECC errors (MBE) occur in the memory and can corrupt cached data and discard it.</p>
Some configured disks have been removed from your system, or are no longer accessible. Check your cables and ensure all disks are present. Press any key or 'C' to continue.	<p>The message indicates that some configured disks were removed. If the disks were not removed, they are no longer accessible.</p> <p>The SAS cables for your system might be improperly connected. Check the cable connections and fix any problems. Restart the system.</p> <p>If there are no cable problems, press any key or &lt;C&gt; to continue.</p>

**Table 7-1. BIOS Errors and Warnings (continued)**

<b>Message</b>	<b>Meaning</b>
Physical disk removed: Physical Disk {x.x.x} Controller {x}, Connector {x}	These two messages appear in the event log when you remove a drive. The first message indicates that the disk was removed and the second message indicates that the device has failed. This feature is working as designed.
Device failed: Physical Disk {x.x.x} Controller {x}, Connector {x}".	<p>A storage component such as a physical disk or an enclosure has failed. The failed component might have been identified by the controller while performing a task such as a rescan or a check consistency.</p> <p>Replace the failed component. You can identify the failed disk as its status displays a red X. Perform a rescan after replacing the disk.</p>
Battery is missing or the battery could be fully discharged. If battery is connected and has been allowed to charge for 30 minutes and this message continues to appear, then contact Technical Support for assistance.	<ul style="list-style-type: none"><li>• The controller battery is missing or damaged.</li><li>• The controller battery is completely discharged and needs to be charged for it to become active. The battery must first be charged, and then it is found by the system several minutes later.</li></ul>

Table 7-2 describes the BBU-related error messages and warnings that display for the BIOS.

**Table 7-2. Backup Battery Unit Errors and Warnings**

<b>Message</b>	<b>Meaning</b>
Memory/Battery problems were detected. The adapter has recovered, but cached data was lost. Press any key to continue.	<p>This message occurs under the following conditions:</p> <ul style="list-style-type: none"><li>• The adapter detects that the cache in the controller cache has not yet been written to the disk subsystem.</li><li>• The controller detects an error-correcting code (ECC) error while performing its cache checking routine during initialization.</li><li>• The controller then discards the cache rather than sending it to the disk subsystem because the data integrity cannot be guaranteed.</li></ul> <p>To resolve this problem, allow the battery to charge fully. If the problem persists, the battery or adapter DIMM might be faulty. In that case, contact Dell Technical Support.</p>

## Virtual Disks Degraded

A redundant virtual disk is in a degraded state when one or more physical disks has failed or is inaccessible. For example, a RAID 1 virtual disk consisting of two physical disks can sustain one physical disk in a failed or inaccessible state failure and become a degraded virtual disk.

To recover from a degraded state, the failed physical disk must be replaced and allowed to rebuild. Upon successful completion of the rebuild process, the virtual disk state changes from degraded to optimal. For the rebuild procedure, see "Performing a Manual Rebuild of an Individual Physical Disk" on page 107.

## Memory Errors

Memory errors can corrupt cached data, so the controllers are designed to detect and attempt to recover from these memory errors. Single-bit memory errors can be handled by the controller and do not disrupt normal operation. A notification is sent if the number of single-bit errors exceeds a threshold value.

Multi-bit errors are more serious, as they result in corrupted data and data loss. The following are the actions that occur in the case of multi-bit errors:

- If an access to data in cache memory causes a multi-bit error when the controller is started with dirty cache, the controller discards the cache contents. The controller generates a warning message to the system console to indicate that the cache was discarded and generates an event.
- If a multi-bit error occurs at run-time either in code/data or in the cache, the controller stops.
- The controller logs an event to the controller internal event log and logs a message during POST indicating that a multi-bit error has occurred.



**NOTE:** In case of a multi-bit error, contact Dell Technical Support.

## Pinned Cache State

If a virtual disk becomes offline or is deleted because of missing physical disks, the controller preserves the dirty cache from the virtual disk. This preserved dirty cache is called pinned cache and is preserved until you import the virtual disk, or discard the cache.

Use the Ctrl+R utility to select whether to import the virtual disk or discard the pinned cache. In the **VD Mgmt** menu, select **Manage Preserved Cache** and follow the steps on the screen.

# General Problems

Table 7-3 describes general problems you might encounter, along with suggested solutions.

**Table 7-3. General Problems**

<b>Problem</b>	<b>Suggested Solution</b>
The device displays in Device Manager but has a yellow bang (exclamation point).	Reinstall the driver. See the driver installation procedures in the section "Installing the Drivers" on page 63.
The device does not appear in Device Manager.	Turn off the system and reseal the controller.
<b>No Hard Drives Found</b> message appears during a CD installation of Microsoft® Windows Server® 2003 or Windows XP because of the following causes: <b>1</b> The driver is not native in the operating system. <b>2</b> The virtual disks are not configured properly. <b>3</b> The controller BIOS is disabled.	The corresponding solutions to the three causes of the message are: <b>1</b> Press <F6> to install the RAID Device Driver during installation. <b>2</b> Enter the BIOS Configuration Utility to configure the virtual disks. See the section "Configuring and Managing RAID" on page 77 for procedures to configure the virtual disks. <b>3</b> Enter the BIOS Configuration Utility to enable the BIOS. See the section "Installing and Configuring Hardware" on page 41 for procedures to configure the virtual disks.

# Physical Disk Related Issues

Table 7-4 describes physical disk-related problems you might encounter and the suggested solutions.

**Table 7-4. Physical Disk Issues**

<b>Problem</b>	<b>Suggested Solution</b>
One of the physical disks in the disk array is in the failed state.	Perform the following actions to resolve this problem: <ul style="list-style-type: none"><li>• Check the backplane for damage.</li><li>• Check the SAS cables.</li><li>• Reseat the physical disk.</li><li>• Contact Dell Technical Support if the problem persists.</li></ul>
Cannot rebuild a fault tolerant virtual disk. <b>NOTE:</b> For more information, see the alert log for virtual disks.	This could result from any of the following: <ul style="list-style-type: none"><li>• The replacement disk is too small or not compatible with the virtual disk. Replace the failed disk with a compatible good physical disk with sufficient capacity.</li></ul>
Fatal errors or data corruption are reported when accessing virtual disks.	Contact Dell Technical Support.



# Physical Disk Failures and Rebuilds

Table 7-5 describes issues related to physical disk failures and rebuilds.

**Table 7-5. Physical Disk Failure and Rebuild Issues**

Issue	Suggested Solution
Rebuilding the physical disks after multiple disks become simultaneously inaccessible.	<p data-bbox="380 368 1003 518">Multiple physical disk errors in a single array typically indicate a failure in cabling or connection and could involve the loss of data. It is possible to recover the virtual disk after multiple physical disks become simultaneously inaccessible. Perform the following steps to recover the virtual disk.</p> <ol data-bbox="380 518 1003 837" style="list-style-type: none"><li data-bbox="380 518 1003 582"><b>1</b> Turn off the system, check cable connections, and reseal physical disks.</li><li data-bbox="380 582 1003 646"><b>2</b> Follow the safety precautions to prevent electrostatic discharge.</li><li data-bbox="380 646 1003 686"><b>3</b> Ensure that all the drives are present in the enclosure.</li><li data-bbox="380 686 1003 837"><b>4</b> Turn on the system and enter into the CTRL+R utility and import the foreign configuration. Press 'F' at the prompt to import the configuration, or press &lt;C&gt; to enter the BIOS configuration utility and either import or clear the foreign configuration.</li></ol> <p data-bbox="380 837 1003 1029">If the VD is redundant and transitioned into DEGRADED state before going OFFLINE, a rebuild operation starts automatically after the configuration is imported. If the VD has gone directly into the OFFLINE state due to a cable pull or power loss situation the VD is imported in its OPTIMAL state without a rebuild occurring.</p> <p data-bbox="380 1029 1003 1125">You can use the BIOS Configuration Utility or Dell OpenManage Storage Management application to perform a manual rebuild of multiple physical disks.</p> <p data-bbox="380 1125 1003 1222">See the section "Performing a Manual Rebuild of an Individual Physical Disk" on page 107 for procedures to rebuild a single physical disk.</p>

**Table 7-5. Physical Disk Failure and Rebuild Issues (continued)**

Issue	Suggested Solution
Rebuilding a physical disk after one of them is in a failed state.	If you have configured hot spares, the PERC 6 controller automatically tries to use one to rebuild a physical disk that is in a failed state. Manual rebuild is necessary if no hot spares with enough capacity to rebuild the failed physical disks are available. You must insert a physical disk with enough storage into the subsystem before rebuilding the physical disk. You can use the BIOS Configuration Utility or Dell OpenManage Storage Management application to perform a manual rebuild of an individual physical disk.  See the section "Performing a Manual Rebuild of an Individual Physical Disk" on page 107 for procedures to rebuild a single physical disk.
A virtual disk fails during rebuild while using a global hot spare.	The global hot spare goes back into <b>HOTSPARE</b> state and the virtual disk goes into <b>FAIL</b> state.
A virtual disk fails during rebuild while using a dedicated hot spare.	The dedicated hot spare goes into <b>READY</b> state and the virtual disk goes into <b>FAIL</b> state.
A physical disk fails during a reconstruction process on a redundant virtual disk that has a hot spare.	The rebuild operation for the inaccessible physical disk starts automatically after the reconstruction is completed.
A physical disk is taking longer than expected to rebuild.	A physical disk takes longer to rebuild when under high stress. For example, there is one rebuild I/O operation for every five host I/O operations.
You cannot add a second virtual disk to a disk group while the virtual disk in that disk group is undergoing a rebuild	The firmware does not allow you to create a virtual disk using the free space available in a disk group if a physical disk in a virtual disk in the disk group is undergoing a rebuild operation.

# SMART Errors

Table 7-6 describes issues related to the Self-Monitoring Analysis and Reporting Technology (SMART). SMART monitors the internal performance of all motors, heads, and physical disk electronics and detects predictable physical disk failures.



**NOTE:** For information about where to find reports of SMART errors that could indicate hardware failure, see the Dell OpenManage Storage Management documentation.

**Table 7-6. SMART Errors**

<b>Problem</b>	<b>Suggested Solution</b>
A SMART error is detected on a physical disk in a redundant virtual disk.	<p>Perform the following steps:</p> <ol style="list-style-type: none"><li>1 Force the physical disk offline.</li></ol> <p><b>NOTE:</b> If a hot spare is present, the rebuild starts with the hot spare after the drive is forced offline.</p> <ol style="list-style-type: none"><li>2 Replace it with a new physical disk of equal or higher capacity.</li><li>3 Perform the <b>Replace Member</b> operation.</li></ol> <p>The <b>Replace Member</b> operation allows you to copy data from a source physical disk of a virtual disk to a target physical disk that is not a part of the virtual disk. See "Using the SMART Feature" on page 24 for more information about the <b>Replace Member</b> feature.</p>
A SMART error is detected on a physical disk in a non-redundant virtual disk.	<p>Perform the following steps:</p> <ol style="list-style-type: none"><li>1 Back up your data.</li><li>2 Use <b>Replace Member</b> or set up a global hot spare to replace the disk automatically.</li></ol> <p>See "Replacing an Online Physical Disk" on page 106 for information about the <b>Replace Member</b> feature.</p> <ol style="list-style-type: none"><li>3 Replace the affected physical disk with a new physical disk of equal or higher capacity.</li><li>4 Restore from the backup.</li></ol>

**Table 7-6. SMART Errors (continued)**

<b>Problem</b>	<b>Suggested Solution</b>
A SMART error occurs during a Consistency Check (CC)	<p>Specify how the Consistency Check operation should perform when a SMART error is encountered.</p> <p>There are two settings, <b>Yes</b> and <b>No</b>. <b>No</b> is the default setting and allows CC to continue when the first error is encountered. The <b>Yes</b> setting halts CC when the first error is encountered.</p> <p>Events are generated in the <b>Event Log</b> when errors are encountered during CC.</p>

## Replace Member Errors

Table 7-7 describes issues related to the **Replace Member** feature.



**NOTE:** For more information about the **Replace Member** features, see "Replacing an Online Physical Disk" on page 106.

**Table 7-7. Replace Member Operation Errors**

<b>Problem</b>	<b>Suggested Solution</b>
The source drive fails during the <b>Replace Member</b> operation.	If the source data is available from other drives in the virtual disk, the rebuild begins automatically on the target drive, using the data from the other drives to generate that data.
Target drive fails	If the target drive fails, the <b>Replace Member</b> operation aborts.
Other drives fail	If the target drive fails and the <b>Replace Member</b> operation aborts but the source data is still available, then the <b>Replace Member</b> operation should continue as <b>Replace Member</b> .

# Linux Operating System Errors

Table 7-8 describes issues related to the Linux operating system.

**Table 7-8. Linux Operating System Errors**

Error Message	Suggested Solution
<pre>&lt;Date:Time&gt; &lt;HostName&gt; kernel: sdb: asking for cache data failed</pre>	<p>This error message displays when the Linux Small Computer System Interface (SCSI) mid-layer asks for physical disk cache settings. Because the controller firmware manages the virtual disk cache settings on a per controller and a per virtual disk basis, the firmware does not respond to this command. Thus, the Linux SCSI mid-layer assumes that the virtual disk's cache policy is <b>Write-Through</b>. SDB is the device node for a virtual disk. This value changes for each virtual disk.</p>
<pre>&lt;Date:Time&gt; &lt;HostName&gt; kernel: sdb: assuming drive cache: write through</pre>	<p>See the section "Physical Disk Management" on page 104 for more information about <b>Write-Through</b> cache.</p> <p>Except for this message, there is no side effect to this behavior. The cache policy of the virtual disk and the I/O throughput are not affected by this message. The cache policy settings for the PERC6 SAS RAID system remain the settings you have already chosen.</p>

**Table 7-8. Linux Operating System Errors (continued)**

Error Message	Suggested Solution
Driver does not auto-build into new kernel after customer updates.	<p>This error is a generic problem for DKMS and applies to all DKMS-enabled driver packages. This issue occurs when you perform the following steps:</p> <ol style="list-style-type: none"><li data-bbox="493 403 893 427">1 Install a DKMS-enabled driver package.</li><li data-bbox="493 438 941 491">2 Run <code>up2date</code> or a similar tool to upgrade the kernel into the latest version.</li><li data-bbox="493 502 779 526">3 Reboot into the new kernel.</li></ol> <p>The driver running in the new kernel is the native driver in the new kernel. The driver package you installed previously in the new kernel does not take effect in the new kernel.</p> <p>Perform the following procedure to make the driver auto-build into the new kernel:</p> <ol style="list-style-type: none"><li data-bbox="493 735 941 852">1 Type: <code>dkms build -m &lt;module_name&gt; -v &lt;module version&gt; -k &lt;kernel version&gt;</code></li><li data-bbox="493 863 956 979">2 Type: <code>dkms install -m &lt;module_name&gt; -v &lt;module version&gt; -k &lt;kernel version&gt;</code></li><li data-bbox="493 991 960 1203">3 Type the following to check whether the driver is successfully installed in the new kernel: <code>DKMS</code>  The following details appear: <code>&lt;driver name&gt;, &lt;driver version&gt;, &lt;new kernel version&gt;: installed</code></li></ol>

**Table 7-8. Linux Operating System Errors (continued)**

<b>Error Message</b>	<b>Suggested Solution</b>
<pre>smartd[smartd[2338] Device: /dev/sda, Bad IEC (SMART) mode page, err=-5, skip device  smartd[2338] Unable to register SCSI device /dev/sda at line 1 of file /etc/smartd.conf</pre>	<p>This is a known issue. An unsupported command is entered through the user application. User applications attempt to direct Command Descriptor Blocks to RAID volumes. The error message does not effect the feature functionality.</p> <p>The <b>Mode Sense/Select</b> command is supported by firmware on the controller. However, the Linux kernel <b>daemon</b> is issuing the command to the virtual disk instead of to the driver IOCTL node. This action is not supported.</p>

## Controller LED Indicators

The external SAS ports on the PERC 6/E adapter have a port status LED per x4 SAS port. This bicolor LED displays the status of any external SAS port. The LED indicates whether all links are functional or only partial links are functional.

Table 7-9 describes the patterns for the PERC 6/E adapter port status.

**Table 7-9. LED Behavior Patterns**

<b>Port State</b>	<b>LED State</b>
Power-on state	Off
Reset state	Off
All links in port connected	Green light on
One or more links are not connected (applicable only in wide port configurations)	Amber light on
All links in the port are disconnected or the cable is disconnected	Off

# Drive Carrier LED Indicators

The LED on the physical disk carrier indicates the state of each physical disk. Each drive carrier in your enclosure has two LEDs: an activity LED (green) and a bicolor (green/amber) status LED as shown in Figure 7-1. The activity LED flashes whenever the drive is accessed.

**Figure 7-1. Drive Carrier LED Indicators**

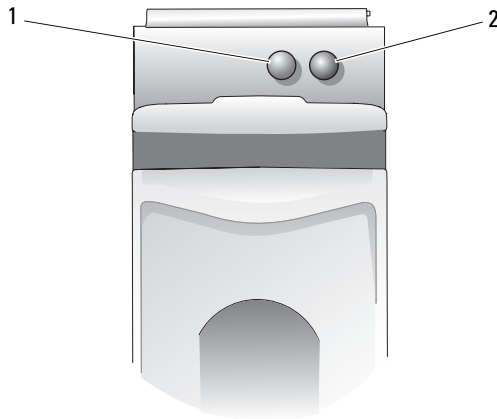

1 activity LED

2 status LED

Table 7-10 lists the flash patterns for the status LED.

**Table 7-10. Drive Carrier Status LEDs**

LED	Description
Off	Slot is empty, drive is not yet discovered by a system
Steady green	Drive is online
Green flashing (250 milliseconds [ms])	Drive is being identified or is being prepared for removal
Green flashing On 400 ms Off 100 ms	Drive is rebuilding or undergoing a <b>Replace Member</b> operation



**Table 7-10. Drive Carrier Status LEDs (continued)**

<b>LED</b>	<b>Description</b>
Amber flashing (125 ms)	Drive has failed
Green/amber flashing Green On 500 ms Amber On 500 ms Off 1000 ms	Predicted failure reported by drive
Green flashing Green On 3000 ms Off 3000 ms Amber On 3000 ms Off 3000 ms	Drive being spun down by user request or other non-failure condition





# Regulatory Notices

For additional regulatory information, please go to the Regulatory Compliance Homepage on [www.dell.com](http://www.dell.com) at the following location: [www.dell.com/regulatory\\_compliance](http://www.dell.com/regulatory_compliance).

## 中国大陆 RoHS

根据中国大陆《电子信息产品污染控制管理办法》（也称为中国大陆 RoHS），以下部分列出了 Dell 产品中可能包含的有毒和/或有害物质的名称和含量。中国大陆 RoHS 指令包含在中国信息产业部 MCV 标准：“电子信息产品中有毒有害物质的限量要求”中。

### Dell 企业产品（服务器、存储设备及网络设备）

部件名称	有毒或有害物质及元素					
	铅 (Pb)	汞 (Hg)	镉 (Cd)	六价铬 (Cr VI)	多溴联苯 (PBB)	多溴联苯醚 (PBDE)
机箱 / 挡板	X	O	X	O	O	O
印刷电路部件 - PCA*	X	O	X	O	O	O
电缆 / 连接器	X	O	X	O	O	O
硬盘驱动器	X	O	X	O	O	O
光盘驱动器 (CD、DVD 等)	X	O	O	O	O	O
磁带 / 介质	X	O	O	O	O	O
软磁盘驱动器	X	O	O	O	O	O
其它 RMSD/ 介质	X	O	O	O	O	O
电源设备 / 电源适配器	X	O	X	O	O	O
电源线	X	O	X	O	O	O
机械部件 - 风扇	X	O	O	O	O	O
机械部件 - 散热器	X	O	O	O	O	O
机械部件 - 电机	X	O	O	O	O	O
机械部件 - 其它	X	O	X	O	O	O
电池	X	O	O	O	O	O
定点设备 (鼠标等)	X	O	O	O	O	O
键盘	X	O	O	O	O	O
快擦写存储器	X	O	O	O	O	O
不间断电源设备	X	O	X	O	O	O
完整机架 / 导轨产品	X	O	X	O	O	O
软件 (CD 等)	O	O	O	O	O	O

\* 印刷电路部件包括所有印刷电路板（PCB）及其各自的离散组件、IC 及连接器。

“0”表明该部件所含有害和有毒物质含量低于 MCV 标准定义的阈值。

“X”表明该部件所含有害和有毒物质含量高于 MCV 标准定义的阈值。对于所有显示 X 的情况，Dell 按照 EU RoHS 采用了容许的豁免指标。

在中国大陆销售的相应电子信息产品（EIP）都必须遵照中国大陆《电子信息产品污染控制标识要求》标准贴上环保使用期限（EPUP）标签。Dell 产品所采用的 EPUP 标签（请参阅实例，徽标内部的编号适用于指定产品）基于中国大陆的《电子信息产品环保使用期限通则》标准。



## **Corporate Contact Details (Taiwan Only)**

Pursuant to Article 11 of the Commodity Inspection Act, Dell provides the following corporate contact details for the certified entity in Taiwan for the products addressed by this document:

Dell B.V. Taiwan Branch

20/F, No. 218, Sec. 2, Tung Hwa S. Road,

Taipei, Taiwan



# Glossary

## A

### **Adapter**

An adapter enables the computer system to access peripheral devices by converting the protocol of one bus or interface to another. An adapter may also provide specialized function. For example, a RAID controller is a type of adapter that provides RAID functions. Adapters may reside on the system board or be an add-in card. Other examples of adapters include network and SCSI adapters.

### **Adaptive Read Ahead**

Adaptive read ahead is a read policy that specifies that the controller begins using **Read-Ahead** caching if the two most recent disk accesses occurred in sequential sectors. If all read requests are random, the algorithm reverts to Non read ahead; however, all requests are still evaluated for possible sequential operation.

### **Array**

A grouping of physical disks that combines the storage space on the physical disks into a single segment of contiguous storage space. The RAID controller can group physical disks on one or more channels into an array. A hot spare drive does not participate in an array.

## B

### **Background Initialization**

Background initialization is the automatic check for media errors on physical disks. It ensures that striped data segments are the same on all physical disks in a virtual disk. The difference between a background initialization and a consistency check is that a background initialization is automatic for new virtual disks. The operation starts within five minutes after you create the disk.

### **Baseport**

Base register of the memory address range provided by the host.

### **Battery Backup Unit (BBU)**

The battery backup unit protects the integrity of the cached data on the controller by providing backup power if there is a complete AC power failure or a brief power outage.

### **BIOS**

Acronym for basic input/output system. Your computer's BIOS contains programs stored on a flash memory chip. The BIOS controls the following: communications between the microprocessor and peripheral devices, such as the keyboard and the video adapter, and miscellaneous functions, such as system messages.

### **BIOS Configuration Utility**

The BIOS Configuration Utility configures and maintains RAID disk groups and virtual disks, and manages the RAID system. Because the utility resides in the controller BIOS, its operation is independent of the operating systems on your system. The BIOS Configuration Utility, also known as Ctrl+R, is built on elements called controls. Each control performs a function. The functions include procedures you can use to configure physical disks and virtual disks.

## **C**

### **Cache**

Fast memory that holds recently accessed data. Using cache speeds subsequent access to the same data. It is most often applied to processor-memory access but also can be used to store a copy of data accessible over a network. When data is read from or written to main memory, a copy is also saved in cache memory with the associated main memory address. The cache memory software monitors the addresses of subsequent reads to see if the required data is already stored in cache memory. If it is already in cache memory (a cache hit), it is read from cache memory immediately and the main memory read is aborted (or not started). If the data is not cached (a cache miss), it is fetched from main memory and saved in cache memory.



## **Caching**

The process of utilizing a high speed memory buffer, referred to as a “cache,” in order to speed up the overall read or write performance. This cache can be accessed at a higher speed than a disk subsystem. To improve read performance, the cache usually contains the most recently accessed data, as well as data from adjacent disk sectors. To improve write performance, the cache may temporarily store data in accordance with its write back policies. See the definition of **Write-Back** for more information.

## **Consistency Check**

An operation to verify that all stripes in a virtual disk with a redundant RAID level are consistent and automatically fix any errors. For RAID 5, 6, 50, and 60 arrays, consistency check verifies correct parity data for each stripe. For RAID 1 and RAID 10 arrays, this operation verifies correct mirror data for each stripe.

## **Controller**

A chip that controls the transfer of data between the microprocessor and memory or between the microprocessor and a peripheral device such as a physical disk or the keyboard. In Storage Management, the hardware or logic that interacts with storage devices to write and retrieve data and perform storage management. RAID controllers perform RAID functions such as striping and mirroring to provide data protection.

## **D**

### **DDR SDRAM**

Acronym for Double Data Rate Synchronous Dynamic Random Access Memory. This is a type of SDRAM that provides data throughput at double the rate of conventional SDRAM. It uses a bursting technique to predict the address of the next memory location to be accessed and allows two data transfers on each clock cycle.

### **Disk**

A non-volatile, randomly addressable, rewriteable mass storage device, including both rotating magnetic and optical storage devices and solid-state storage devices, or non-volatile electronic storage elements.

**Disk Array**

A collection of disks from one or more disk subsystems combined using a configuration utility. The utility controls the disks and presents them to the array operating environment as one or more logical drives.

**Disk Group**

A logical grouping of disks attached to a RAID controller on which one or more virtual disks can be created, such that all virtual disks in the disk group use all of the physical disks in the disk group.

**Disk Migration**

Moving a virtual disk or a hot spare from one controller to another by detaching the physical disks and re-attaching them to the new controller.

**Disk Roaming**

Moving disks from one slot to another on a controller.

**Disk Subsystem**

A collection of disks and the hardware that controls them and connects them to one or more controllers. The hardware can include an intelligent controller, or the disks can attach directly to a system I/O bus controller.

**Distributed Parity**

Parity involves an extra bit added to a byte or word to reveal errors in storage (in RAM or disk) or transmission. Parity is used to generate a set of redundancy data from two or more parent data sets. The redundancy data can be used to rebuild one of the parent data sets. In distributed parity, the parity data are distributed among all the physical disks in the system. If a single physical disk fails, it can be rebuilt from the parity of the applicable data on the remaining physical disks.

**DKMS**

Acronym for Dynamic Kernel Module Support. Designed by Dell™, DKMS creates a framework in which kernel-dependent module source can reside so that it is easy to rebuild modules as you upgrade kernels. DKMS is used in the upgrade process for drivers for Red Hat® Linux and SUSE® Linux Enterprise Server.

## **DUD**

Acronym for driver update diskette. A DUD is an image of a diskette stored as a regular file. To use it, you have to create the content to a real diskette from this file. The steps used to create the diskette depend on how the image is supplied.

## **E**

### **ECC Errors**

Acronym for error correcting code. ECC errors occur in the memory and can corrupt cached data so that it must be discarded. Single-bit ECC errors can be handled by the firmware and do not disrupt normal operation. A notification is sent if the number of single-bit errors exceeds a threshold value. ECC double-bit errors are more serious, as they result in corrupted data and data loss.

### **Enclosure**

A structure, such as a system, which contains physical disks that are grouped together to create virtual disks.

### **Enclosure Management**

Intelligent monitoring of the disk subsystem by software and/or hardware. The disk subsystem can be part of the host system or can reside in an external disk enclosure. Enclosure management helps you stay informed of events in the disk subsystem, such as a physical disk or power supply failure. Enclosure management increases the fault tolerance of the disk subsystem.

### **Exclusive-OR**

A Boolean operation used to create a parity bit that can be used to restore data affected by a damaged file or failed physical disk. The management utility compares data from two physical disks and creates a parity bit that is stored on a third physical disk. This operation is used for RAID levels that use parity bits, such as RAID 5, which used distributed parity. Also known as X-OR.

## **F**

### **Failed Physical Disk**

A physical disk that has ceased to function, that consistently functions improperly, or that is inaccessible.

## **Fault Tolerance**

Fault tolerance is the capability of the disk subsystem to undergo a single drive failure per disk group without compromising data integrity and processing capability. The PERC 6 controllers provide this support through redundant virtual disks in RAID levels 1, 5, 6, 10, 50, and 60.

Fault tolerance is often associated with system availability because it allows the system to be available during drive failures. In case a disk fails, the PERC 6 controllers support hot spare disks and the auto-rebuild feature.

## **Firmware**

Software stored in read-only memory (ROM) or Programmable ROM (PROM). Firmware is often responsible for the behavior of a system when it is first turned on. A typical example would be a monitor program in a system that loads the full operating system from disk or from a network and then passes control to the operating system.

## **Foreign Configuration**

A RAID configuration that already exists on a replacement physical disk that you install in a system. You can import the existing configuration to the RAID controller or clear it so you can create a new one.

## **Format**

The process of writing a specific value to all data fields on a physical disk, to map out unreadable or bad sectors. Because most physical disks are formatted when manufactured, formatting is usually done only if a physical disk generates many media errors.

## **G**

### **GB**

Acronym for gigabyte(s). A gigabyte equals 1,024 megabytes or 1,073,741,824 bytes ( $2^{30}$  bytes).

## H

### **Host System**

Any system on which the RAID controller is installed. Mainframes, workstations, and personal systems can all be considered host systems.

### **Hot Spare**

An idle, powered on, stand-by physical disk ready for immediate use in case of disk failure. It does not contain any user data. A hot spare can be dedicated to a single redundant virtual disk or it can be part of the global hot-spare pool for all virtual disks controlled by the controller.

When a disk fails, the controllers' firmware automatically replaces and rebuilds the data from the failed physical disk to the hot spare. Data can be rebuilt only from virtual disks with redundancy (RAID levels 1, 5, 10, or 50; not RAID 0), and the hot spare must have sufficient capacity.

If the hot spare is designated as having enclosure affinity, it attempts to rebuild any failed disks on the backplane within which it resides prior to rebuilding any other on other backplanes.

### **Hot Swap**

Replacement of a failed component while the system is running and operating normally.

## I

### **Initialization**

The process of writing zeros to the data fields of a virtual disk and, in fault tolerant RAID levels, generating the corresponding parity to put the virtual disk in a Ready state. Initializing erases previous data and generates parity so that the virtual disk passes a consistency check. Virtual disks can work without initializing, but they can fail a consistency check because the parity fields have not been generated.

## **Inter-IC**

Inter-IC, also known as I<sup>2</sup>C, is a multi-master bus, meaning that more than one chip can be connected to the same bus. Each chip can act as a master and initiate a data transfer.

## **L**

### **Load-balancing**

Load balancing is a method of spreading work between two or more computers, network links, CPUs, physical disk drives, or other resources. Load balancing is used to maximize resource use, throughput, or response time. In the PERC 6 controllers, the balancing service is performed by the firmware.

You can choose between a single path for load balancing, and a “round-robin” load balancing scheme. In single path, the firmware can detect multiple paths to a device, and use only a single path for I/O activity to that device. The secondary path is used if a failure is detected on the primary path.

In a simple round-robin scheme, if load balancing is enabled for the controller, the firmware implements a round-robin scheme to issue I/Os to the redundant path device. The round-robin scheme issues one I/O down one path, and the other I/O down the second path, and so on. There is no restriction on firmware regarding which path to choose first. If load balancing is disabled, the firmware can use any one of the available paths to issue I/Os, and it should continue to use the same path for all further I/O activity. On reboot or path failure, the firmware again chooses any available path.

### **Logical Disk**

A set of contiguous chunks on a physical disk. Logical disks are used in array implementations as constituents of logical volumes or partitions. Logical disks are normally transparent to the host environment, except when the array containing them is being configured.

## **M**

### **MB**

Acronym for megabyte(s). The term *megabyte* means 1,048,576 bytes ( $2^{20}$  bytes); however, when referring to hard drive storage, the term is often rounded to mean 1,000,000 bytes.

## **Mirroring**

The process of providing complete redundancy using two physical disks, by maintaining an exact copy of one physical disk's data on the second physical disk. If one physical disk fails, the contents of the other physical disk can be used to maintain the integrity of the system and to rebuild the failed physical disk.

## **Multi-bit ECC Errors**

ECC errors are errors that occur in the memory, which can corrupt cached data so that it has to be discarded. ECC double-bit errors are serious, as they result in corrupted data and data loss. In case of double-bit ECC errors, contact Dell Technical Support.

## **Multi-pathing**

PERC 6 firmware provides support for detecting and using multiple paths from the RAID controllers to the SAS devices that are in enclosures. Devices connected to enclosures have multiple paths to them. With edundant paths to the same port of a device, if one path fails, another path can be used to communicate between the controller and the device.

## **N**

### **Non Read Ahead**

Non read ahead is a cache read policy. If you select Non read ahead in the BIOS Configuration Utility, the controller does *not* read sequentially ahead of requested data and store the additional data in cache memory, anticipating that the data is needed soon. Non read ahead is most effective when accessing random data.

### **Non Redundant Virtual Disk**

A non-redundant virtual disk is one which does not have redundant data on physical disks that can be used to rebuild a failed physical disk. A RAID 0 virtual disk consists of data striped across the physical disks, without disk mirroring or parity to provide redundancy. This provides for high data throughput but offers no protection in case of a physical disk failure.

## **Ns**

Acronym for nanosecond(s), one billionth of a second.

## **NVRAM**

Acronym for non-volatile random access memory. A storage system that does not lose the data stored on it when power is removed. NVRAM is used to store configuration data on the RAID controller.

## **O**

### **Offline**

A physical disk is offline when it is part of a virtual disk but its data is not accessible to the virtual disk.

### **Online**

An online device is a device that is accessible.

### **Online Capacity Expansion**

Operation to add capacity to an existing virtual disk by adding an additional physical disk while the host system is active, and without affecting data availability.

### **Operating Environment**

An operating environment can include the host system where physical disks are attached, any I/O buses and controllers, the host operating system and any additional software required to manage the virtual disk. For host-based arrays, the operating environment includes I/O driver software for the member disks but does not include array management software, which is regarded as part of the array itself.

## **P**

### **Parity**

An extra bit added to a byte or word to reveal errors in storage (in RAM or disk) or transmission. Parity is used to generate a set of redundancy data from two or more parent data sets. The redundancy data can be used to rebuild one of the parent data sets. However, parity data does not fully duplicate the parent data



sets. In RAID, this method is applied to entire physical disks or stripe elements across all physical disks in a virtual disk. Parity consists of dedicated parity, in which the parity of the data on two or more physical disks is stored on an additional physical disk, and distributed parity, in which the parity data are distributed among all the physical disks in the system. If a single physical disk fails, it can be rebuilt from the parity of the applicable data on the remaining physical disks.

### **Partition**

A logical structure on a contiguous segment of storage on a physical disk or virtual disk recognized by an operating system.

### **Patrol Read**

A preventive measure that includes review of your system for possible physical disk errors that could lead to drive failure and damage data integrity. The **Patrol Read** operation can find and possibly resolve any potential problem with physical disks prior to host access. This can enhance overall system performance because error recovery during a normal I/O operation may not be necessary.

### **PHY**

The interface required to transmit and receive data packets transferred across the serial bus.

Each PHY can form one side of the physical link in a connection with a PHY on a different Dell-qualified SATA device. The physical link contains four wires that form two differential signal pairs. One differential pair transmits signals, while the other differential pair receives signals. Both differential pairs operate simultaneously and allow concurrent data transmission in both the receive and the transmit directions.

### **Physical Disk**

A non-volatile, randomly addressable device for storing data. Physical disks are rewritable and commonly referred to as disk drives.

## Physical Disk States

A physical disk can be in one of the following states:

- **Un-configured Good:** A disk accessible to the RAID controller but not configured as a part of a virtual disk or as a hot spare.
- **Hot Spare:** A physical disk that is configured as a hot spare.
- **Online:** A physical disk can be accessed by the RAID controller and is a part of the virtual disk.
- **Rebuild:** A physical disk to which data is being written to restore full redundancy for a virtual disk.
- **Failed:** A physical disk that was originally configured as Online or Hot Spare, but on which the firmware detects an unrecoverable error.
- **Un-configured Bad:** A physical disk on which the firmware detects an unrecoverable error; the physical disk was Un-configured Good or the physical disk could not be initialized.
- **Missing:** A physical disk that was Online, but which has been removed from its location.
- **Offline:** A physical disk that is part of a virtual disk but which has invalid data as far as the RAID configuration is concerned.
- **None:** A physical disk with the unsupported flag set. An Un-configured Good or Offline physical disk that has completed the prepare for removal operation.

## Protocol

A set of formal rules describing how to transmit data, generally across a network or when communicating with storage subsystems. Low-level protocols define the electrical and physical standards to be observed, bit- and byte-ordering, and the transmission and error detection and correction of the bit stream. High-level protocols deal with the data formatting, including the message syntax, the terminal to system dialogue, character sets, sequencing of messages, etc.

## **R**

### **RAID**

Acronym for Redundant Array of Independent Disks (originally Redundant Array of Inexpensive Disks). It is an array of multiple independent physical disks managed together to yield higher reliability and/or performance exceeding that of a single physical disk. The virtual disk appears to the operating system as a single storage unit. I/O is expedited because several disks can be accessed simultaneously. Redundant RAID levels (RAID levels 1, 5, 6, 10, 50, and 60) provide data protection.

#### **RAID Level Migration**

RAID level migration (RLM) changes the array from one RAID level to another. It is used to move between optimal RAID levels. You can perform a RLM while the system continues to run, without having to reboot. This avoids downtime and keeps data available to users.

#### **RAID Levels**

A set of techniques applied to disk groups to deliver higher data availability, and/or performance characteristics to host environments. Each virtual disk must have a RAID level assigned to it.

#### **RAID Management Utility**

A RAID management utility is used to configure physical disks into disk groups and virtual disks. The BIOS Configuration Utility is also known as Ctrl+R. Use the BIOS Configuration Utility if no operating system has been installed yet on the controller. The BIOS Configuration Utility is built on elements called controls. Each control performs a function. The functions include procedures you can use to configure physical disks and virtual disks.

The Dell OpenManage™ Storage Management configures the disks after you have installed the operating system. Storage Management enables you to perform controller and enclosure functions for all supported RAID and non-RAID controllers and enclosures from a single graphical or command-line interface without requiring the use of the controller BIOS utilities.

SAS RAID Storage Manager configures, monitors, and maintains the PERC 6 controllers, battery backup units, and other devices running on a system.

## **Read-Ahead**

A memory caching capability in some controllers that allows them to read sequentially ahead of requested data and store the additional data in cache memory, anticipating that the additional data is required soon. **Read-Ahead** supplies sequential data faster, but is not as effective when accessing random data.

## **Rebuild**

The regeneration of all data to a replacement disk in a redundant virtual disk (RAID level 1, 5, 6, 10, 50, or 60) after a physical disk failure. A disk rebuild normally occurs without interrupting normal operations on the affected virtual disk, though some degradation of performance of the disk subsystem can occur.

## **Rebuild Rate**

The percentage of central processing unit (CPU) resources devoted to rebuilding.

## **Reconstruct**

The act of remaking a virtual disk after changing RAID levels or adding a physical disk to an existing virtual disk.

## **Redundancy**

The provision of multiple interchangeable components to perform a single function to cope with failures and errors. Common forms of hardware redundancy are disk mirroring, implementations of parity disks, or distributed parity.

## **Redundant Virtual Disk**

A redundant virtual disk is one which has redundant data on physical disks in the disk group that can be used to rebuild a failed physical disk. A virtual disk can use disk striping across the physical disks, disk mirroring or parity to provide redundancy. This offers protection in case of a physical disk failure.

## **Replace Member**

The procedure used to copy data from a source physical disk of a virtual disk to a target physical disk that is not a part of the virtual disk. The **Replace Member** operation is often used to create or restore a specific physical configuration for an array (for example, a specific arrangement of array members on the device I/O buses). The **Replace Member** operation can be run automatically or manually.

Typically, a physical disk fails or is expected to fail, and the data is rebuilt on a hot spare. The failed physical disk is replaced with a new disk. Then the data is copied from the hot spare to the new physical disk, and the hot spare reverts from a rebuild drive to its original hot spare status. The **Replace Member** operation runs as a background activity, and the virtual disk is still available online to the host.

### **Replacement Disk**

A physical disk replacing a failed member disk in a virtual disk.

### **Replacement Unit**

A component or collection of components in a system or subsystem that is always replaced as a unit when any part of the collection fails. Typical replacement units in a disk subsystem include disks, controller logic boards, power supplies and cables.

### **Reversible Hot Spare**

When you use the **Replace Member** procedure, after data is copied from a hot spare to a new physical disk, the hot spare reverts from a rebuild drive to its original hot spare status.

### **RPM**

Acronym for Red Hat Package Manager. RPM is a software manager used to install, remove, query, and verify the software on your system. RPMs are used in the driver update procedures for Red Hat Enterprise Linux and SUSE LINUX Enterprise Server (SLES).

### **S**

### **SAS**

Acronym for Serial Attached SCSI. SAS is a serial, point-to-point, enterprise-level device interface that leverages the proven Small Computer System Interface (SCSI) protocol set. The SAS interface provides improved performance, simplified cabling, smaller connectors, lower pin count, and lower power requirements when compared to parallel SCSI. PERC 6 controllers leverage a common electrical and physical connection interface that is compatible with Serial ATA technology.

## **SATA**

Acronym for Serial Advanced Technology Attachment. A physical storage interface standard, is a serial link that provides point-to-point connections between devices. The thinner serial cables allow for better airflow within the system and permit smaller chassis designs.

## **SCSIport**

The SCSIport driver is a feature of the Microsoft® Windows® storage architecture, delivering SCSI commands to the storage targets. The SCSIport driver works well with storage using parallel SCSI.

## **Single Bit ECC Errors**

ECC stands for error correcting code. ECC errors are errors that occur in the memory, which can corrupt cached data so that it has to be discarded. Single-bit ECC errors can be handled by the firmware and do not disrupt normal operation. A notification is sent if the number of single-bit errors exceeds a threshold value.

## **SMART**

Acronym for Self-Monitoring Analysis and Reporting Technology.

The self-monitoring analysis and reporting technology (SMART) feature monitors the internal performance of all motors, heads, and drive electronics to detect predictable drive failures. This feature helps monitor drive performance and reliability, and protects the data on the drive. When problems are detected on a drive, you can replace or repair the drive without losing any data.

SMART-compliant disks have attributes for which data (values) can be monitored to identify changes in values and determine whether the values are within threshold limits. Many mechanical failures and some electrical failures display some degradation in performance before failure

## **SMP**

Acronym for Serial Management Protocol. SMP communicates topology management information directly with an attached SAS expander device. Each PHY on the controller can function as an SMP initiator.

**Spanning**

The method by which nested RAID levels (such as RAID 10, 50, and 60) are constructed from multiple sets of basic, or single RAID levels. For example, a RAID 10 is made up of multiple sets of RAID 1 arrays where each RAID 1 set is considered a span. Data is then striped (RAID 0) across the RAID 1 spans to create a RAID 10 virtual disk. The same concept holds true for RAID 50 and 60 where multiple sets of RAID 5 or RAID 6 can be combined together with striping. Spanning is generally used when referencing these three nested RAID levels.

**Spare**

A physical disk available to replace another physical disk in case that physical disk fails.

**SSP**

Acronym for Serial SCSI Protocol. SSP enables communication with other SAS devices. Each PHY on the SAS controller can function as an SSP initiator or SSP target.

**Storport**

The Storport driver has been designed to replace SCSIport and work with Windows 2003 and beyond. In addition, it offers better performance for RAID controller newer protocols (like SAS), providing higher I/O throughput rates, improved manageability, and an upgraded miniport interface. For example, while SCSIport allows a maximum of 254 commands per controller, Storport allows 254 command per logical unit number (LUN).

**STP**

Acronym for Serial Tunneling Protocol, STP, enables communication with a Dell-qualified SATA device through an attached expander. Each PHY on the SAS controller can function as an STP initiator.

**Stripe Element**

A stripe element is the portion of a stripe that resides on a single physical disk. See also *striping*.

### **Stripe Element Size**

The total disk space consumed by a stripe not including a parity disk. For example, consider a stripe that contains 64 KB of disk space and has 16 KB of data residing on each disk in the stripe. In this case, the stripe element size is 16 KB and the stripe size is 64 KB.

### **Striping**

Disk striping writes data across all physical disks in a virtual disk. Each stripe consists of consecutive virtual disk data addresses that are mapped in fixed-size units to each physical disk in the virtual disk using a sequential pattern. For example, if the virtual disk includes five physical disks, the stripe writes data to physical disks one through five without repeating any of the physical disks. The amount of space consumed by a stripe is the same on each physical disk. The portion of a stripe that resides on a physical disk is a *stripe element*. Striping by itself does not provide data redundancy. Striping in combination with parity does provide data redundancy.

## **V**

### **Virtual Disk**

A virtual disk refers to storage created by a RAID controller from one or more physical disks. Although a virtual disk may be created from several physical disks, it is seen by the operating system as a single disk. Depending on the RAID level used, the virtual disk may retain redundant data in case of a disk failure.

## **W**

### **Write-Back**

In **Write-Back** caching mode, the controller sends a data transfer completion signal to the host when the controller cache has received all the data in a disk write transaction. Data is written to the disk subsystem in accordance with policies set up by the controller. These policies include the amount of dirty/clean cache lines, the number of cache lines available, elapsed time from the last cache flush, and others.

### **Write-Through**

In **Write-Through** caching mode, the controller sends a data transfer completion signal to the host when the disk subsystem has received all the data and has completed the write transaction to the disk.



# Index

## B

- background initialization, 25, 135
  - stopping, 107
- baseport, 135
- battery
  - installing transportable battery
    - backup, 45
  - management, 30
  - removing from PERC 5/E Adapter, 53
- BIOS, 103, 136
- BIOS Configuration Utility, 79, 101-103, 136
  - controller management, 102
  - Foreign View menu, 103
  - menu navigation controls, 80
  - menu options, 96
  - menus, 96
  - physical disk management, 101
  - rebuild menu, 102
  - starting, 79
  - virtual disk management, 97

## C

- cables
  - SAS, 120
- cache, 136

- compatibility
  - with existing RAID controllers, 24
- consistency check, 88, 100, 137
- controller, 137, 148
  - descriptions, 15
- controller management, 102

## D

- disk groups
  - deleting, 95
- disk migration, 27
- disk mirroring, 18
- disk roaming, 27
- disk striping, 18
- display/update parameters, 100
- distributed parity, 138
- driver diskette, 64
- driver installation, 63
  - NetWare, 75
- drivers
  - installation, 63
  - Microsoft operating system
    - installation, 66

## **E**

electrostatic discharge. *See* ESD  
ESD, 12

## **F**

fault tolerance, 34  
    features, 34  
foreign configuration, 103  
Foreign Configuration View, 103

## **H**

hot swap, 141  
hot swapping, 36

## **I**

initialization, 141

## **L**

LED  
    behavior patterns, 127  
    operation, 27

## **M**

manual rebuild, 107

## **N**

NetWare driver installation, 75  
Novell NetWare  
    drivers, 63  
Novell Netware, 63

## **O**

operating system support, 16  
operating systems, 16

## **P**

parity, 19, 36, 144  
    distributed, 138  
Patrol Read, 38  
    behavior, 38  
    behavior details, 39  
    configuration, 39  
    modes, 39

## **PCI**

    architecture, 16

## **PERC**

    features, 21  
    overview, 15

## **PERC 6**

    controller descriptions, 15

physical disk  
    actions, 101

physical disks  
  actions, 101  
  management, 101  
post error messages, 111

## **R**

RAID, 141  
  configuration, 77  
  configuration and  
    management, 77  
  configuration functions, 83  
  configuration information, 34  
  definition, 17, 147  
  description, 17  
  level migration, 147  
  levels, 17, 100, 147  
  management, 77  
  parity, 145  
  summary of levels, 17  
RAID level, 84  
RAID levels, 147  
read policy, 85  
rebuild, 102  
  manual, 107  
Red Hat Enterprise Linux, 63  
  creating a driver diskette, 69  
  installing with the driver update  
    diskette, 71  
replacement disk, 149

## **S**

safety instructions  
  for preventing ESD, 12  
SAS, 149  
  cables, 120  
  controller descriptions, 15  
  devices, 15  
  overview, 15  
SATA, 150  
SCSIport, 150  
SMART technology, 24  
spare, 151  
Storport, 151  
stripe element size, 84

## **T**

troubleshooting, 111  
  general problems, 119  
  physical disk issues, 120  
  post error messages, 111  
  SMART error, 123-124

## **V**

virtual disks  
  degraded, 117  
  deleting, 95  
  management, 97  
  menu options, 100, 103  
  parameters, 84  
  setting up, 102, 104

## **W**

Windows, 63

    drivers, 63

    updating drivers, 68

Windows XP Driver

    Installation on an Existing  
    System, 76

write policy, 84